



Casa d'Arredo dal 1946

**progettazione**  
*bespoke furniture*

*vol. 1*  





## Our corporate

Nata nel 1946 a Verona, il cuore della lavorazione del legno in Italia, Tosato è oggi un'azienda strutturata e una firma d'arredamento a livello internazionale. Per presentarla preferiamo lasciare spazio a i suoi numeri:

*Founded in 1946 in Verona, the heart of woodworking in Italy, Tosato is today a structured company and an international furniture brand To present it we prefer to leave space to its numbers:*



Da anni firmiamo l'arredamento di hotel, ville e appartamenti in Europa, Asia, America e Oceania, portando in ogni "viaggio" un pezzo di Verona. Verona città degli innamorati e culla del vino.

**Realizziamo progetti d'arredo completi, complementi per l'esposizione, oggetti di design.**

All'interno dei nostri uffici, abbiamo uno studio di progettazione, cuore pulsante dell'innovazione dei nostri prodotti: abbiamo deciso di sviluppare quest'area, strutturandola, per lavorare con architetti ed arredatori, con lo scopo di soddisfare sempre, il nostro cliente finale.

*For years we have been designing the furnishings of hotels, villas and apartments in Europe, Asia, America and Oceania, bringing a piece of Verona on every trip. Verona, city of lovers and cradle of wine.*

**We carry out complete furnishing projects, expository complements, design objects.**

*Inside our headquarter we have a design office, the heart of innovation in our products. We decided to develop this area, structuring it, to work with architects and interior designers, in order to always satisfy our final Customer.*

**2**  
sedi produttive

con falegnameria e  
lucidatura interna  
**2 production sites**  
with carpentry and  
internal polishing plant

**13**  
falegnamerie

lavorano per noi  
**13 partner carpentry**  
workshops

**375**  
prodotti

a catalogo  
**375 items**  
in our catalogue

**2**  
sedi

con ufficio progettazione  
**2 headquarters**  
with project office

**3**  
lucidature

lavorano per noi  
**3 partner polishing plants**

**46**  
finiture

standard  
**46 standard finishes**

**8900**  
m<sup>2</sup>

operativi  
**8900 m<sup>2</sup>**  
total working areas

**640**  
mobili

prodotti ogni mese  
**640 pieces of monthly**  
production

**32**  
nazioni

servite nel mondo  
**32 nations**  
served worldwide

## Guida d'uso Catalogue User Guide

1



**Scegli il tuo stile.**  
Scegli tra gli stili proposti o inviaci il tuo progetto.

**Choose your style.**  
Choose Tosato's style or send us your own project.

2



**Scegli gli accessori.**  
Abbina gli accessori scegliendoli nelle collezioni.

**Choose the accessories.**  
Match the accessories choosing them among our collections.

3



**Inviaci le misure del tuo ambiente.**  
Oltre alle misure di massima puoi inviarci la tua idea: foto, schizzi, immagini.

**Send us the dimensions of your "ambiente".**  
You can send us your project or idea. We will develop it with the help of technical drawings, render and 3d models with the methods and the standards of an international company.

4



**Sviluppiamo il progetto per fartelo visualizzare.**  
Realizziamo disegni tecnici, render, modelli 3d.

**We develop your project so you can visualize.**  
We realize technical drawings, render and 3d models.

5



**Realizziamo il tuo arredamento e lo garantiamo 12 anni.**

**We produce and guarantee for 12 years**

Arredare su misura...  
Noi lo facciamo!

***Bespoke Projects***  
*We make things happen*

## Indice *Index*

<b>Camera Z / Room Z</b>	<b>12</b>
<b>Pareti e librerie / Living storage</b>	<b>20</b>
Pareti giorno contemporanee / <i>Contemporary wall units</i>	22
Pareti giorno classiche / <i>Classical wall units</i>	42
<b>Armadi e cabine / Wardrobe and fitted closets</b>	<b>58</b>
Armadi contemporanei / <i>Contemporary wardrobes</i>	60
Armadi classici / <i>Classical wardrobes</i>	68
<b>Boiserie</b>	<b>82</b>
Boiserie contemporanee / <i>Contemporary wood panneling</i>	86
Boiserie classiche / <i>Classical wood panneling</i>	88
<b>Eteera wine living Soluzioni per il vino / Wine division</b>	<b>100</b>
<b>Personalizza / Customize</b>	<b>116</b>
<b>Anteprima Catalogo Progettazione 2.0: Tosato cucine! Bespoke Furnitures Catalogue preview 2.0: Kitchens by Tosato!</b>	<b>124</b>



*Rilassati, raccogliti, allontanati da te ogni  
altro pensiero. Lascia che il mondo che ti  
circonda sfumi nell'indistinto.*

*Italo Calvino*



*Camera Z*  
*Bed room Z*



## Pasquale Piroso

Il nuovo concept di stanza Z pensata e progettata dalla "matita" dall'architetto Pasquale Piroso (studio Loft Canova), noto per importanti lavori di design come al recente opera di illuminazione di Cascina Valadier a Roma. Un'architettura sottrattiva che elimina il superfluo e mira all'esaltazione dei materiali, della luce e delle atmosfere. Il concept Z è creato per favorire la progettazione e l'interior sia per **ambienti privati** che per **spazi ricettivi**.



*Z room's new concept has been thought and developed by the architect Pasquale Piroso ( studio Loft Canova), known for his important design works such as the recent lighting work for the Cascina Valadier, in Rome.  
A subtractive architecture that eliminates all the excess and aims to exalt the materials, light and atmospheres.  
The Z concept has been created to promote the design and the interior design for both **private** and **hospitality spaces**.*

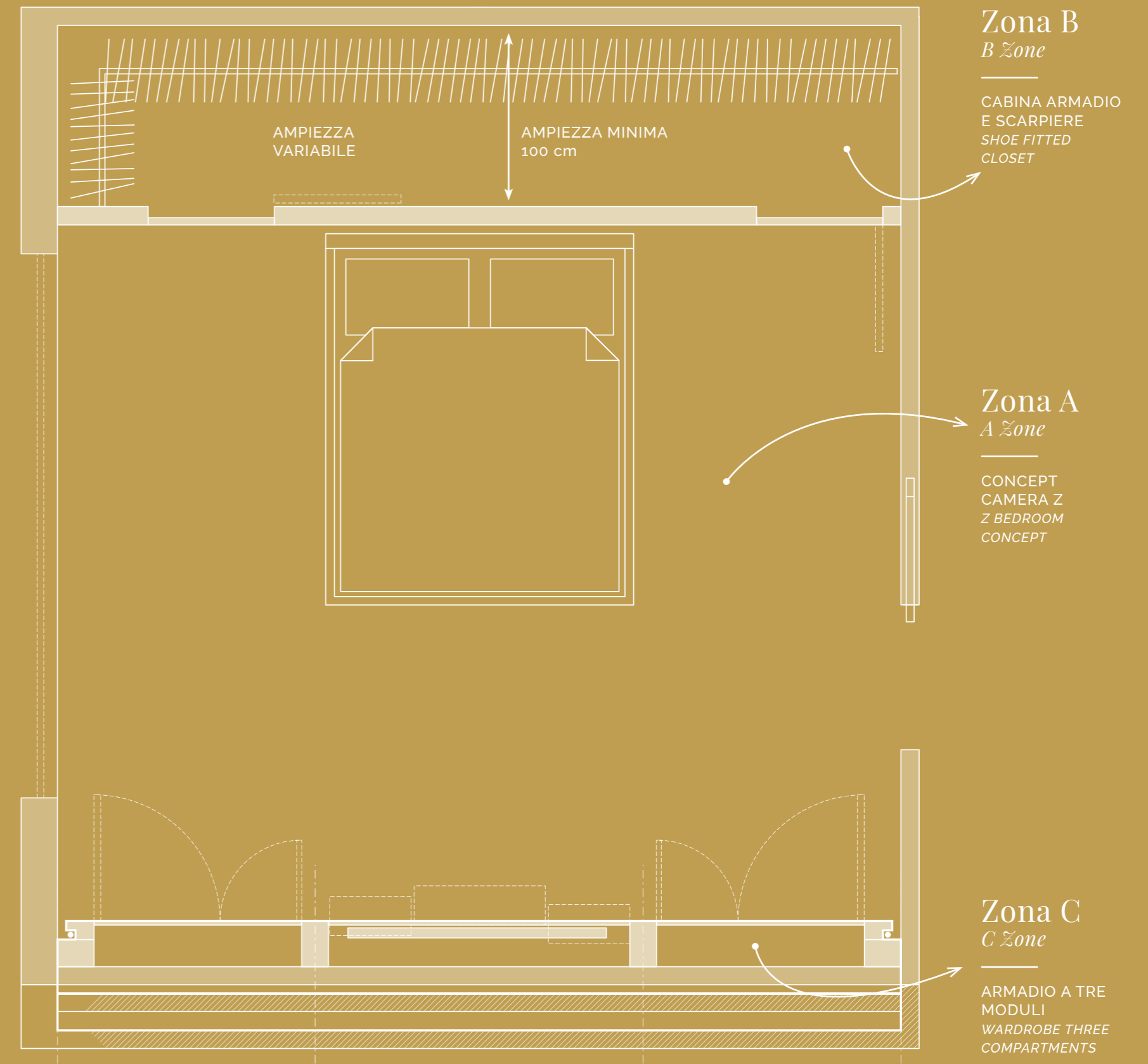





## Zona C C Zone

ARMADIO CON INSERTI  
CABINET WITH INSERTS

In questa camera tutto scompare, la cassetiera sparisce nella quinta di una parete che guarda e riflette la bellezza del un letto. La TV scompare, ma poi riappare dietro ad uno specchio.

*In this room everything is hidden, the chest of drawers hides behind the scenes. The TV disappears as well but then it reappears behind a mirror.*



*L'essenza e la bellezza di un protagonista.  
The essence and beauty of the protagonist.*

Il concept della camera Z è l' ideale anche per la realizzazione di camere d'hotel, unendo al design la grande funzionalità degli spazi ricavati al di sotto dell'ordine e della pulizia delle forme.

*the concept of the z room is also ideal for the creation of hotel rooms, combining design with high functionality.*

17.24  
Armadio a tre moduli  
wardrobe three compartments

F84 bianco liscio

## Zona A A Zone

CONCEPT CAMERA Z  
CONCEPT Z BED

Disegno e particolari costruttivi vengono studiati su misura e sono basati sulle esigenze del cliente.

*The drawings and the architectural particulars are customized and based on our customer's needs.*



42.20  
Letto Z  
Z Bed

F85 Canaletto trasparente  
171X220 H 220

*In noce canaletto con fasce led laterali  
In canaletto walnut with led slide lighting*

*Su misura!  
Customizable!*





17.23  
**Armadio a parete porta scarpe**  
*Wardrobe with shoe holder*  
 F84 Bianco liscio

17.22  
**Cabina armadio con porte scorrevoli dipinte**  
*Wardrobe with sliding printed door*  
 F84 Bianco liscio

*Una cabina armadio  
 elegante, ariosa e  
 funzionale  
 An elegant, airy and  
 functional wardrobe*

**Zona B**  
*B Zone*

CABINA ARMADIO E SCARPIERE  
 WARDROBE AND SHOE CABINETS

Cabina interamente  
 personalizzabile

*The walk-in wardrobe is  
 completely customized*

*Made in Italy Le ante diventano arte  
 grazie alle stampe.  
 Made in Italy The doors become art  
 thanks to the paintings  
 completely customized  
 studied by Loft Canova.*



Z1  
 Dipinto



Z2  
 Dipinto



Z3  
 Dipinto



Alcuni soggetti tra quelli che hanno  
 ispirato i progetti fin qui realizzati.  
 Potrete richiedere il catalogo completo  
 oppure richiedere un dipinto esclusivo,  
 completamente personalizzato.

*Here some of the subjects that have  
 inspired the projects carried out so far.  
 You can request the full catalogue or  
 you can choose an exclusive painting,  
 completely customized.*



*“Due delle stelle più belle del firmamento»  
(II, ii, 15) Romeo rivolto a Giulietta*

*Shakespeare*



*Pareti e librerie*  
*Living storage*

Pareti giorno contemporanee e classiche  
*Contemporary and classical wall units*



  
*Istinto*

*Resina naturale*  
Natural resin



*Marmo nero maquinia*  
Black maquinia marble



*Separé in cristallo*  
Glass partition



*Ante laccate*  
Lacquered doors



**Legno canaletto**

Grazie alle sue qualità materiche (quali elasticità e resistenza) ed estetiche (la colorazione e le venature naturali) il canaletto è il "must have" di ogni collezione d'arredo di tendenza: un legno che esalta e viene esaltato da inserti multimaterici, come quelli, qui rappresentati, del marmo nero maquinia, del cristallo, e degli innovativi pannelli in resina o da giochi di luci.

**Canaletto walnut**

*Canaletto walnut grows in the north east of America, where the most important growth areas of canaletto walnut are concentrated for the **quality of the plants who are destined for furnishings**. Thanks to its aesthetic and physical qualities (elasticity and resistance) the canaletto walnut, with its brownish color and dark brown veins, is considered a **precious wood for the realization of classic and modern furniture**.*

*Apertura ante con sistema push-pull*  
Doors with push-pull

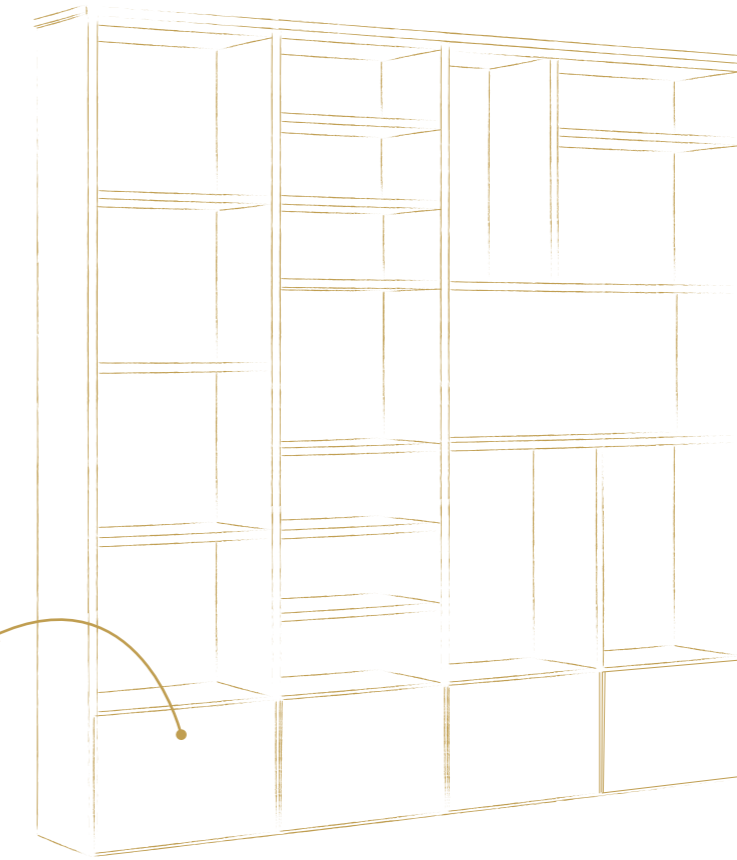

*Mensola sospesa che crea un passaggio*  
Suspended shelf that creates a passage

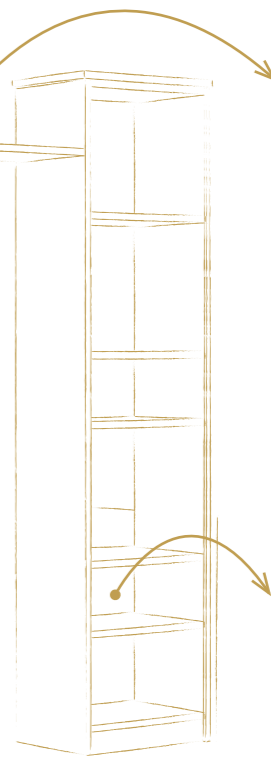

*Inserti e moduli componibili*  
Customizable insert and modules



60.33  
**Parete divisorio**  
Partition wall

F85 Canaletto trasparente  
F74 Nero liscio  
L 412 P 45 H 265 cm

*Completa il tuo soggiorno Istinto... Canaletto Style*  
*Complete your Istinto living... CanalettoStyle*

*Scegli la colorazione del tessuto*  
*Choose the color of the fabric*



53.11

**Divano**  
*Sofa*

F85 Canaletto trasparente  
F27 tessuto / fabric  
L 210 P 90 H 92 cm

*Struttura in canaletto*  
*Canaletto walnut structure*





23.204  
**Madia**  
*Sideboard*

F85 Canaletto trasparente  
FG28 tessuto / fabric  
L 253 P 60 H 87 cm



*Mini frigo a scomparsa*  
*Retractable mini fridge*



*Ante in tessuto*  
*Fabric doors*



  
*Aria*



TOSATO

60.31  
**Parete giorno**  
*Unit wall*

F84 Bianco liscio  
L 551 P 44 H 250 cm

*Anta in vetro*  
*Glass door*

*Fascia di tamponamento*  
*Fitted to the niche*



60.29  
**Libreria**  
*Bookcase*

F84 Bianco liscio  
L 270 P 35 H 265 cm



  
*Linea*

*Un unico mobile per più esigenze... Noi lo facciamo.  
An unique wall unit with multiple functions... We make it*

*Legno massello  
Solid wood*



*Maniglia incassata  
Cut out handle*

*Boiserie  
Pannelling*

60.34  
*Parete bi facciale  
Double sided wall*  
F84 Bianco liscio  
L 393 P 60 H 280 cm



*Intercapedine per passaggio cavi  
Space for cable passage*



*Ripiani estraibili  
Removable shelves*

*Double sided*

*Parete notte  
Night side*



*Parete giorno  
Day side*





  
*Mito*

**Apertura push-pull**  
Push-pull open

Arredi pensati apposta per le esigenze di ogni spazio abitativo: chiedici un progetto personalizzato!

*Furniture designed specifically for your needs and your living spaces: request your bespoke project.*



60.35

**Parete giorno**  
*Unit wall*

f71 grigio style  
f73 cipria / blush  
L 240 P 47 H 205 cm

**Composizione small per gli spazi più piccoli**  
*Small composition for smaller spaces*

**Non semplici moduli, ma soluzioni ideali per i tuoi spazi: chiedici un progetto personalizzato!**  
*Not simple modules, but ideal solutions for your spaces: ask us for a personalized project!*

**Componi il tuo living**  
*Customize your living room*



60.32

**Parete giorno**  
*Unit wall*

f71 grigio style  
f73 cipria / blush  
L 360 P 47-40-30 H 205 cm

**Frassino**

Il frassino è un legno robusto, tenace ed elastico. Il suo colore nei frassini Americani è uniformemente grigiobruno fino a bruno e chiaramente scolorito, mentre nei frassini europei è da grigiobruno fino ad oliva e spesso increspato. Nella nostra Casa d'arredo selezioniamo le migliori tipologie cromatiche e le essichiamo secondo una tradizione tramandata di generazione in generazione

**Ash**

The ash belongs to the heaviest and hardest woods, tenacious and elastic. Its color in the American ash is uniformly gray-brown to brown and clearly discolored, while in the European ash it is from gray-brown to olive and often rippled. Our company choose the best selection followed by a careful drying period to offer an optimal product as always from generation to generation.



  
*Metropoli*

*Reinventare il passato... Noi lo facciamo!*  
*Reinvent the past... We can do it!*



60.28  
**Libreria da studio**  
*Bookcase*

f63 nero spigolato  
 L 350 P 60 H 205 cm

*Schienali imbottiti*  
*Quilted back panel*

*Inserti in ottone*  
*Brass inserts*



Led su ribaltina bar  
*Led light for bar section*

Led sul cappello  
*Led on top frame*

**Completa il tuo studio Metropoli!**  
*Complete your Metropoli study!*

12.63  
**Porta vaso**  
*Vase stand*  
 f63 nero spigolato  
 L 36 P 36 H 108 cm



25.23  
**Vetrinetta**  
 con piano vassoio  
*Expositor*  
*with tray top*  
 f63 nero spigolato  
 L 64 P 38 H 69

21.56  
**Vetrinetta**  
 con piano vassoio  
*Expositor*  
*with tray top*  
 f63 nero spigolato  
 L 180 P 80 H 80  
 F626



52.13  
**Poltrona**  
*Armchair*  
 f63 nero spigolato  
 L 75 P 87 H 104 cm  
 rg. 27



*Personalizziamo ogni  
 dettaglio del tuo ambiente  
 We customize every detail of  
 your room*





  
*Desideri*

## Vintage living

60.17  
**Libreria da studio**  
*Bookcase*

f98 noce non battuto  
 L 466.5 - 374 P 45 H 255.5 cm

Un eclettico mix tra contemporaneo e retro.  
 An eclectic mix of contemporary and retro.

**Pensa in grande!**  
*Dreaming big!*

Componi la tua libreria su misura. Realizziamo angoli adatti ai tuoi ambienti, che sanno rispettare le proporzioni e le dimensioni del tuo spazio, sia grande che piccolo.

*Compose your own bespoke bookcase. We create suitable corners for your ambience, that respect the proportions and the dimensions of your space, both large and small.*

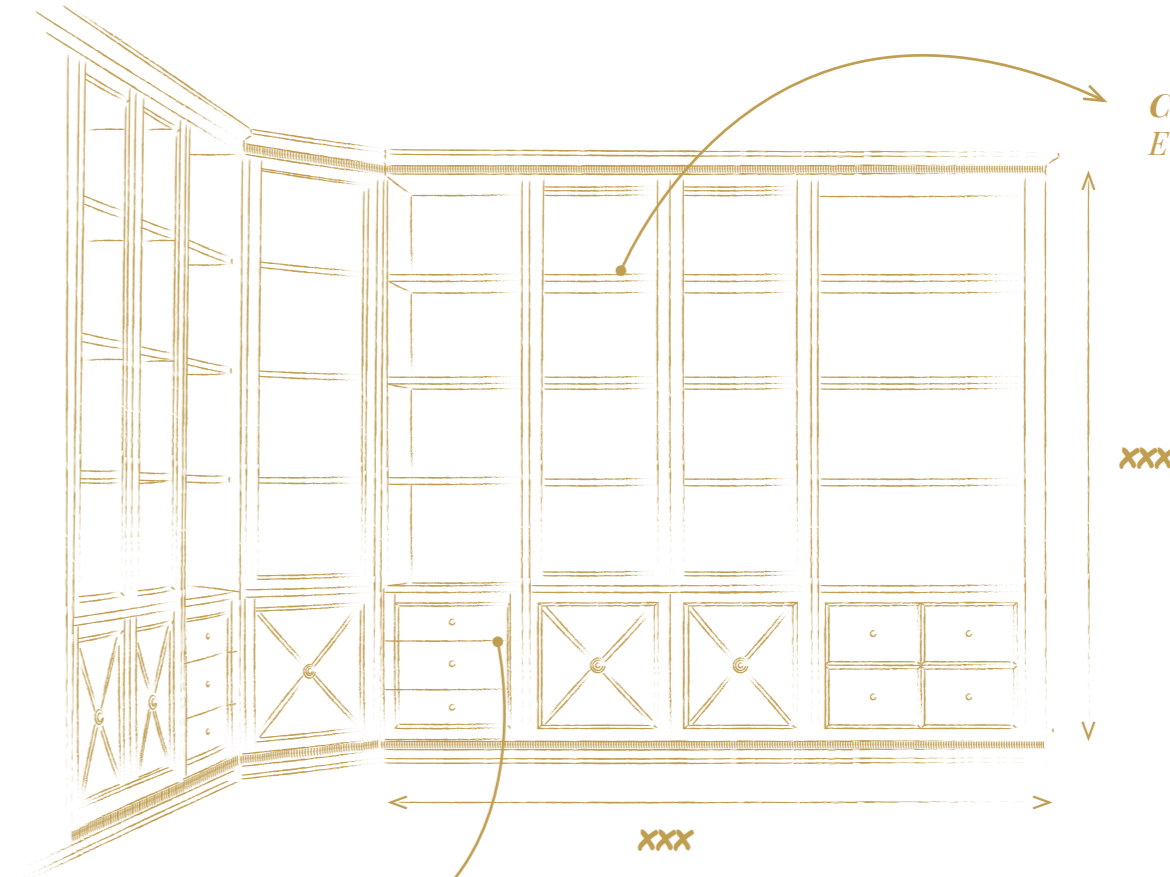

**Ciliegio Europeo**  
 European cherry

**Componilo come preferisci,**  
*ante, cassetti, accessori...*  
 Compose it as you prefer,  
*doors, drawers, accessories...*

**Ciliegio Europeo**

**European cherry**

Legno che garantisce resistenza e durata, essenza nobile che rappresenta una scelta storica dell'arredo made in Verona. Le sue venature marroni e rossicce lo rendono ricco di possibilità estetiche.

Wood that guarantees resistance and durability, a noble essence that represents a historic choice of furniture made in Verona. Its brown and reddish veins make it rich in aesthetic possibilities.





*Scegli le misure  
per i tuoi spazi  
Choose the sizes for  
your spaces*



60.10  
**Libreria da studio**  
*Bookcase*

f50 Acqua marina  
L 331 P 45 H 255.5 cm

*Completa la tua casa Desideri Style:  
chiedi il catalogo!  
Complete your Desideri Style home:  
ask for the catalogue!*



  
*Idea*

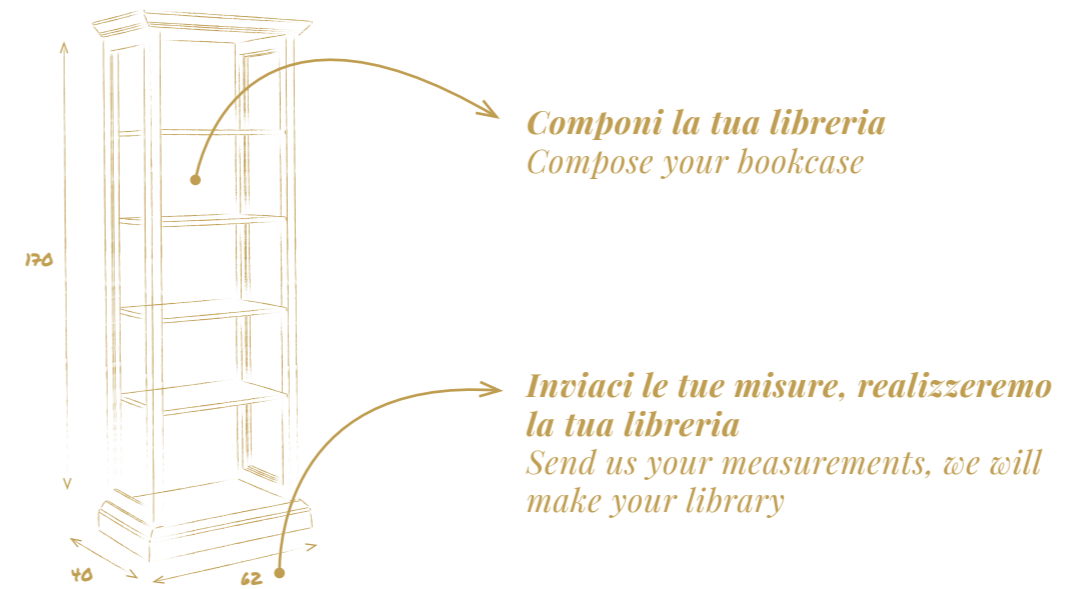

**Leggerezza costruttiva**  
Lightness of construction

Un classico leggero, elegante ma giovane,  
ideale per personalizzare i tuoi spazi.

*A light, elegant but young classic, ideal for  
personalizing your spaces.*

60.25

**Libreria**  
Bookcase

f67 grigio miele  
L 164 P 45 H 206 cm

*Vano giorno*  
Open space

60.27

**Libreria**  
Bookcase

f67 grigio miele  
L 62 P 40 H 170 cm



*Porta in vetro*  
Glass door

60.26

**Libreria con porta**  
Bookcase with door

f67 grigio miele  
L 62 P 40 H 170 cm



*Ogni armadio è come la biblioteca di Borges,  
illimitato e progressivo, inesauribile.*

*Elvira Seminara*



*Armadi e cabine*  
*Wardrobe and fitted closets*

*Armadi contemporanei e classici*  
*Contemporary and classical wardrobes*



  
*Aria*

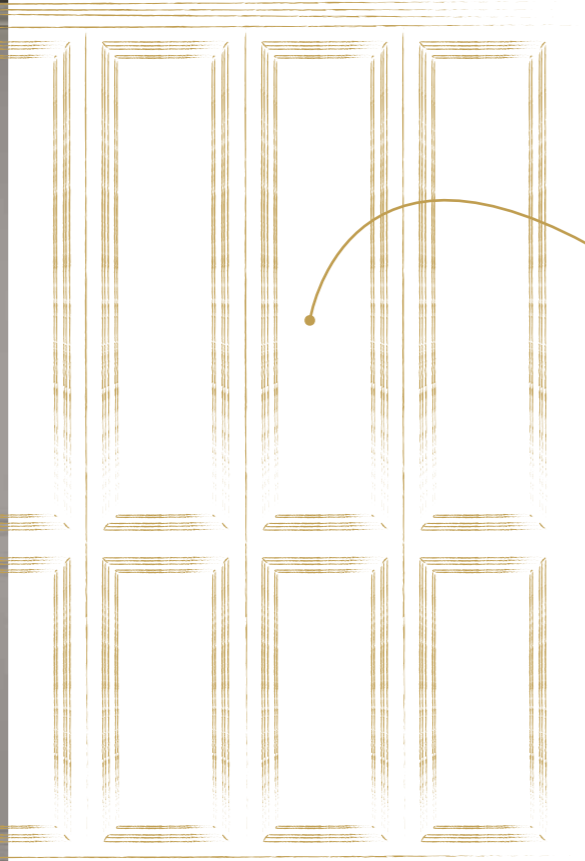

*Su misura per la tua parete*  
Customized to your wall

300



60.36

**Armadio**  
Wardrobe

f84 bianco liscio  
L 300 P 61 H 263 cm

*Da un singolo armadio ad una intera cabina, inviaci le misure e le tue esigenze, riceverai il nostro progetto.*  
*From a single wardrobe to an entire fitted closet, send us the measurements and your needs, you will receive our project.*







  
*Linea*

*Un unico mobile per più esigenze... Noi lo facciamo.  
An unique unit with multiple functions.. We can make it*



*Parete notte  
Night side*



60.34  
**Parete bifacciale**  
*Double sided wall*  
f84 bianco liscio  
L 393 P 60 H 280 cm



*Parete giorno  
Day side*



  
*Desideri*

# Elegant Comfort



Portagioie  
Jewel case

Servetto  
Pull down

Scarpiera  
Shoe rack

*Eleganza componibile e modulabile.  
A modular system of great versatility rich in design and elegance.*



*Seleziona gli  
accessori della  
tua cabina  
armadio  
Select your  
wardrobe acces-  
sories*

*Le misure sono  
quelle che ci  
fornisci tu!  
You provide the  
size!*



*Dettagli...*  
*Details...*



Porta pantaloni  
Holder trousers

Cassetti a vista  
Glass front drawers

60.30  
**Cabina armadio**  
*Walk-in closet*

f36 avorio dorato  
L 250 + 400 + 250 P 60 H 255,5 cm



◇  
*Desideri Gold*



17.08 gold  
**Armadio**  
 Wardrobe

f54 noce oro  
 320 x 67 h 255 cm



17.04 gold  
**Armadio**  
 Wardrobe

f54 noce oro  
 L 170 P 67 H 220 cm

*Ciliegio Europeo*  
 European cherry



*Cambia i tuo colori e cambia la tua vita!  
Changes your colors and change your life!*



17.04  
**Armadio**  
Wardrobe

f49 avorio patinato  
L 170 P 67 H 220 cm

*Specchio interna*  
Internal mirror





*Angolo, sottoscala, tetto mansardato... Non ci spaventano!  
Corners, under stairs, mansard roofs.. They are not a problem for us!*



*Armadio per ogni angolo  
della tua casa  
Closet for every corner of  
your home*

*Ante ampie o strette,  
decidi tu  
Wide or narrow doors,  
you decide*



17.21  
**Armadio**  
Wardrobe  
f48 ciliegio biondo  
218 + 168 x 60 h 270 cm

*Tamponamento a muro  
Fitted to the wall*



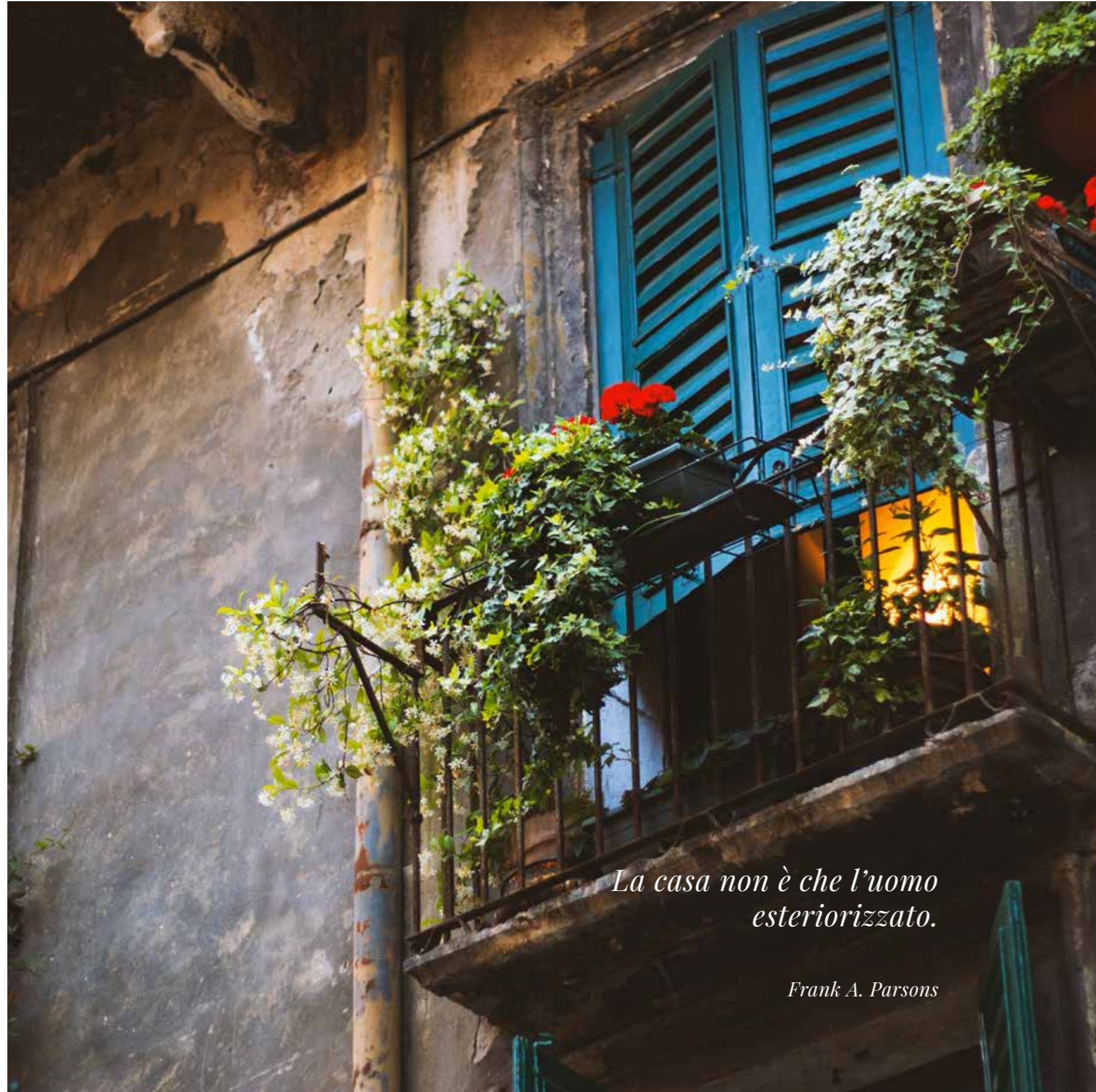

*La casa non è che l'uomo  
esteriorizzato.*

*Frank A. Parsons*



## *Boiserie*

Boiserie contemporanee e classiche  
*Contemporary and classical wood panelling*



  
*Istinto*

*Il punto d'incontro tra la contemporaneità ed il romantico*  
*The meeting point between the contemporary and the romantic*

**Boiserie**  
*Pannelling*

fg28 tessuto / fabric  
 f85 canaletto trasparente

50.44  
**Sedia**  
*Chair*

F85 Canaletto trasparente  
 66x62x80

Boiserie stile istinto con pannelli  
 in noce canaletto e pannelli  
 tappezzati in tessuto.

*Istinto style wood panneling with  
 solid walnut canaletto panels  
 and panels.*



*Sedia in canaletto abbinata*  
*Matching canaletto chair*



  
*Idea*

*Scegli tra Boiserie/lambris in legno massello o l'intelligente Kit boiserie:...*  
*Choose between solid wood boiserie/lambris or the intelligent boiserie kit:...*



**Kit cornice Idea:**  
 Corrimano, battiscopa, cornice  
 soffitto e cornice decorativi.  
 Materiale: legno di tiglio.

**Idea frame kit:**  
 Handrail, skirting board, ceiling  
 frame and decorative frame.  
 Material: linden wood.

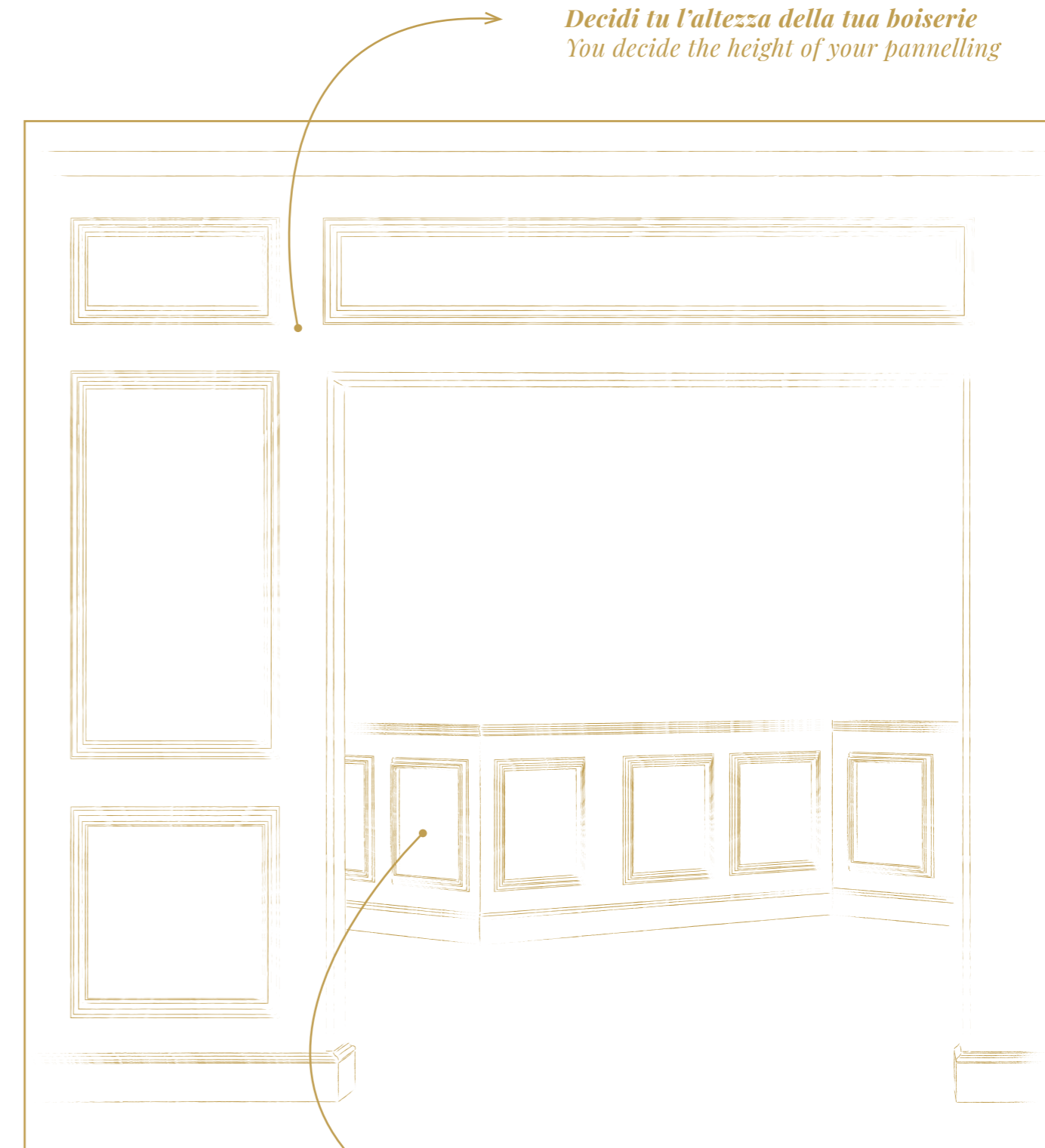

**Decidi tu l'altezza della tua boiserie**  
*You decide the height of your panneling*

**Scegli il tuo colore preferito**  
*Choose your favorite color*



  
*Desideri*  
Boiserie - Lambris

*Dover, il colore del cielo inglese è il nostro colore dell'anno!  
Dover, the color of the English sky, is our color of the year!*



*Scegli il tuo tessuto  
Choose your fabric*

*Lambris o boiserie: scegli l'altezza, il disegno, il colore...noi la progettiamo e realizziamo!  
Lambris or panelling: choose the height, the design, the color...we design and make it!*



*L'intero salotto come lo vuoi tu  
The entire living room as you prefer*



*Una lambris per ogni occasione  
A lambris for every occasion*

*Modelliamo la tua lambris in funzione dei tuoi inserti  
We model your lambris according to your inserts*



Lambris a specchiera  
Mirror lambris

*Scegli il colore che più  
si addice alla tua stanza  
Choose the best color for  
your room*

*La vuoi classica o contemporanea? Scegli la tua colonna preferita.  
Do you want it classic or contemporary? Choose your favorite column.*

*Particolare attenzione ai dettagli  
Particular attention to detail*





*Il vino, specialmente in Italia,  
è la poesia della terra.*

*Mario Soldati*



  
*Eterea*  
*Wine Living*

*Soluzioni per cantine, ristoranti, hotel, case*  
*Solutions for winery, restaurants, hotels, homes*

# Soluzioni espositive

Wine living solutions



*Ripiano estraibile  
porta bottiglie  
Removable shelf  
bottle holder*

70.04  
f85 Canaletto trasparente  
F84 Nero liscio  
100x40 H 68

*Progettiamo a partire dai tuoi spazi  
We design from your spaces*



**Espositore porta bottiglie  
in acciaio cromato**  
Bottle holder expositor in  
chromed steel

**Led freddi, esaltano la bottiglia senza modificare  
le caratteristiche organolettiche del vino**  
Cold leds, enhance the bottle without changing the  
organoleptic characteristics of the wine



70.01  
f85 canaletto trasparente  
f74 nero liscio  
50X50 H254

70.05  
f85 canaletto trasparente  
f74 nero liscio  
100X40X80

**Atmosfera e illuminazione: canaletto naturale e nero laccato lucido, luci a led ed inserti multi-materiale.**  
Atmosphere and lighting: natural and black glossy lacquered canaletto walnut, led lights and multi-material inserts.

**Concept**

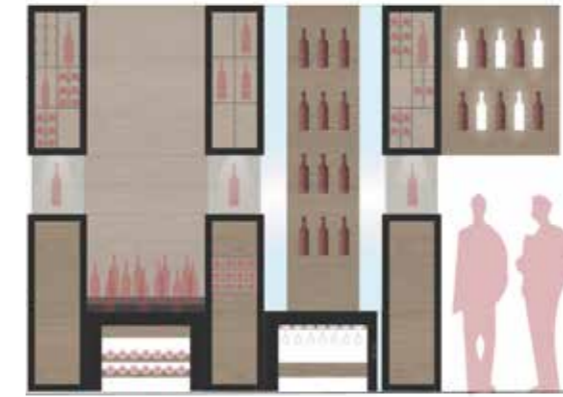

**Led freddi**  
Cold light led

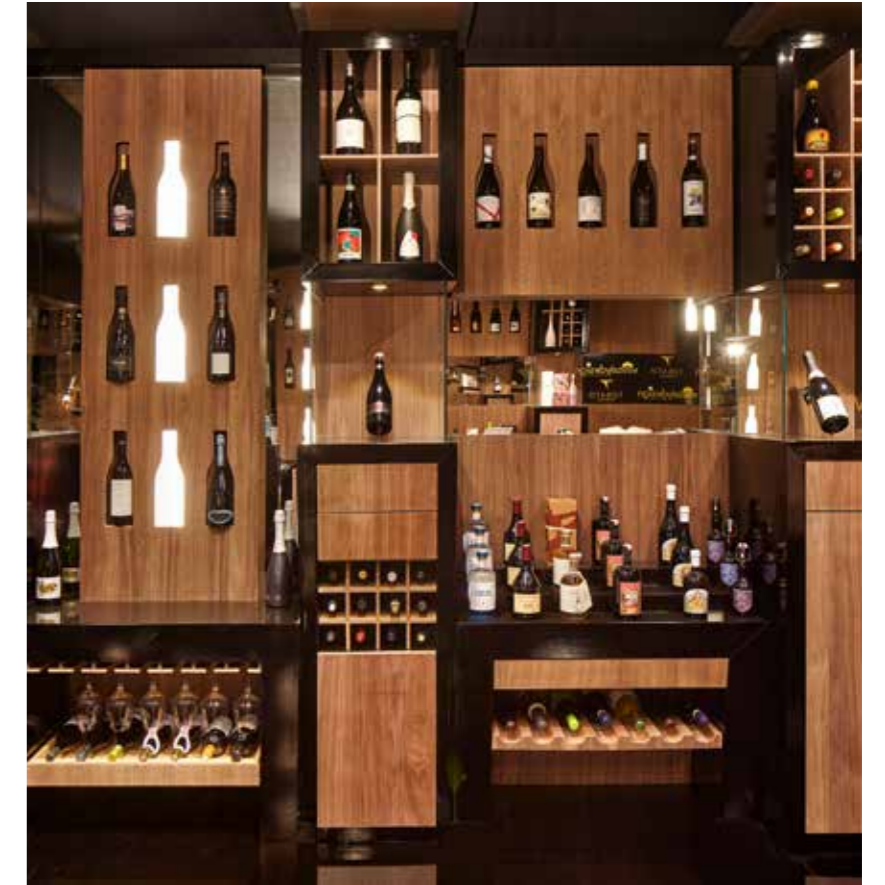

**Per Enotecche, Ristoranti e Bar**  
Pareti espositive, tecnologie a scomparsa,  
mobili porta frigo per la mescita.

**The ideal solution for wine shops**  
Restaurants and wine bar.  
Exhibition walls, foldaway technologies,  
fridge cabinet furniture, excellent for wine  
pouring.

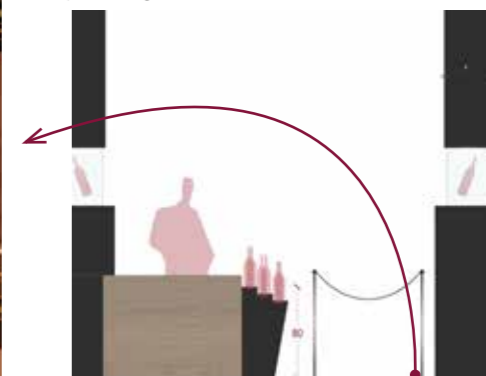

70.08  
f85 canaletto trasparente  
f74 nero liscio  
130X45X254

**Dal progetto alla realtà**  
From design to reality

*Per dividere i vostri spazi con classe e funzionalità  
To divide your spaces with class and functionality*

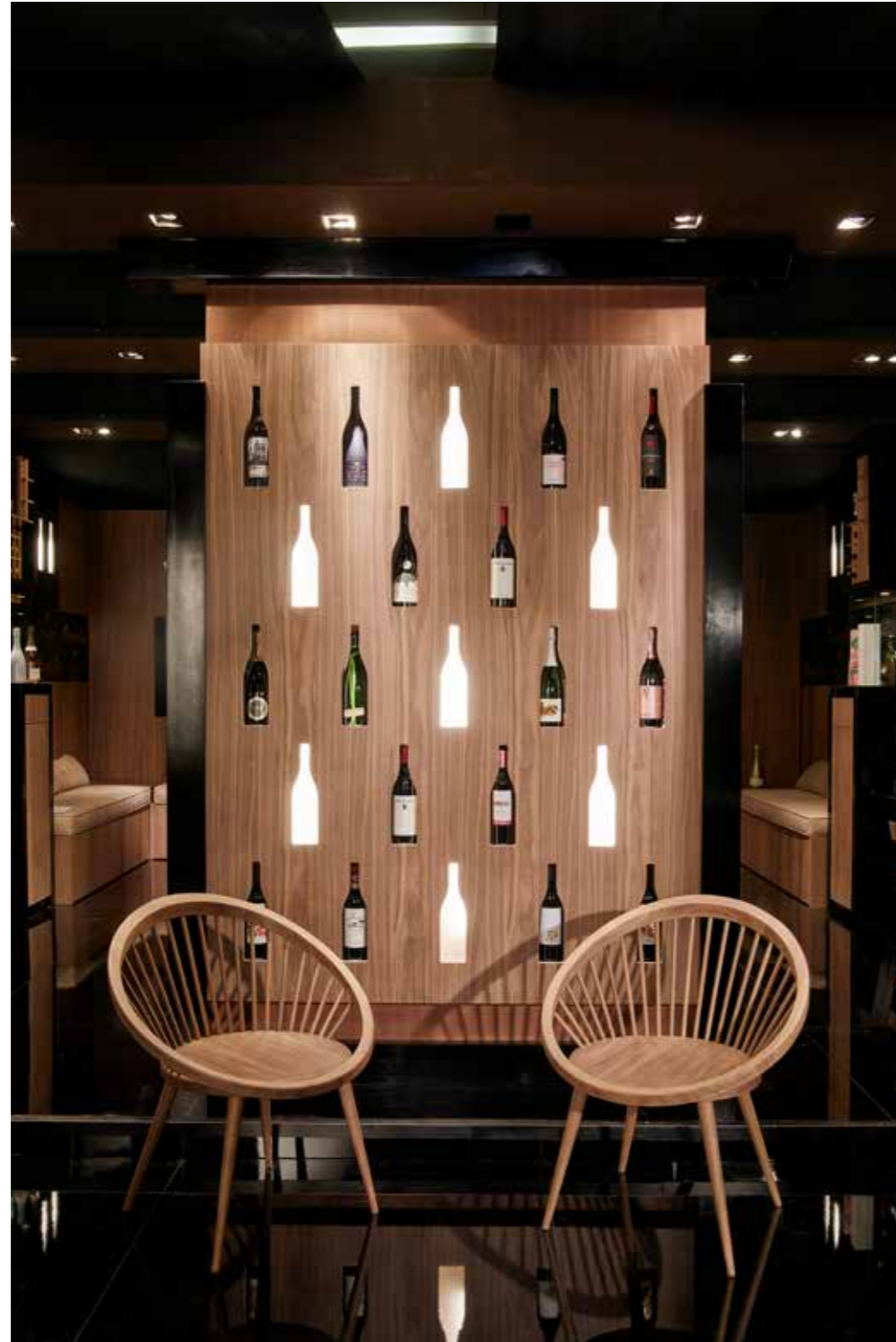

Parete autoportante bi-facciale  
*Double sided wall*

*Soluzioni  
illuminotecniche  
Lighting solutions*

*Frigobar  
Mini-bar*

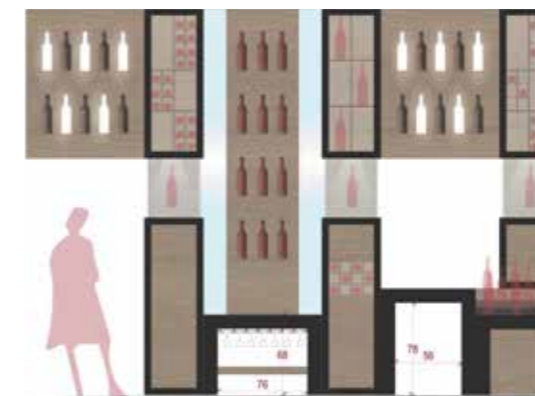

*Carrello  
push-pull  
Push-pull trolley*

70.09  
f85 canaletto  
trasparente  
f74 nero liscio  
204x74 H254

***Parete su misura***

ideata per l'arredo dell'ambiente, con funzione di portabottiglie retroilluminata. In questo esempio la parete in uno dei due lati, ospita un piano frigo e porta bicchieri con funzione di zona bar.

***Bespoke wall unit***

created to furnish your space, with bottle holders and back-lighting. In this example we can find a fridge cabinet and glasses holders in order to create a bar area



*Tavolo espositivo con piano in cristallo temperato e inserti in ottone*  
*Expositor table with tempered glass top and brass inserts*



*Box porta bottiglie*  
*Bottle holder box*

*Panca con sottostante vano contenitivo*  
*Bench with storage compartment underneath*

22.89

f85 canaletto trasparente  
 f63 nero spigolato  
 180x180 H79



*Personalizza con il tuo logo*  
Customize with your logo



12.64  
**Porta boule**  
con secchiello del ghiaccio incluso  
*Boule holder*  
*with ice bucket included*  
f85 canaletto trasparente  
36x36 H84



*Inserti in ottone*  
*Brass inserts*



*Vetro serigrafabile*  
*Silk-screened glass*

25.23  
**Vetrinetta**  
con piano vassoio  
*Expositor*  
*with tray top*  
f63 nero spigolato  
64x38 H79





*Personalizza l'interno  
del tuo mobile bar  
Customize the interior  
of your bar cabinet*

25.22  
**Mobile bar**  
Cabinet bar

f65 noce e nero spigolato  
127x60 H164



23.204  
**Madia**  
Sideboard

f85 canaletto trasparente  
fg28 tessuto / fabric  
253x60 H87



*Mini frigo a scomparsa  
Retractable mini fridge*



*Porta calici  
Chalice holder*

Scegli tra i nostri modelli o inviaci la tua idea  
*Choose from our models or send us your idea*

Scegli lo stile della struttura che fa per te  
*Chose the structure you prefer*

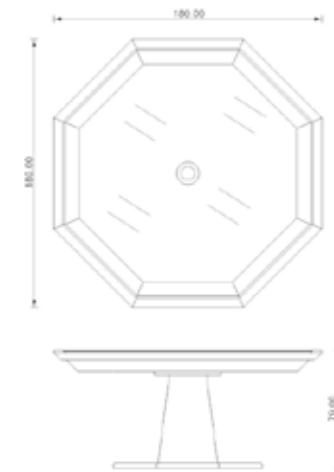

22.89  
 L 180 P 180 H 79 cm  
 f63 NERO SPIGOLATO



70.01  
 L 50 P 50 H 254 cm  
 f74 NERO LISCIO +  
 f85 CANALETTO



70.02  
 L 50 P 50 H 254 cm  
 f74 NERO LISCIO  
 f85 CANALETTO



70.03  
 L 61 P 7 H 186 cm  
 f85 CANALETTO

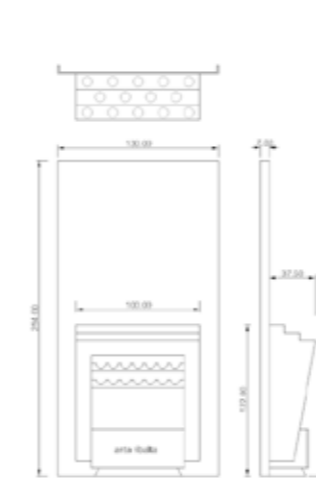

70.08  
 L 130 P 45 H 254 cm  
 f74 NERO LISCIO  
 f85 CANALETTO

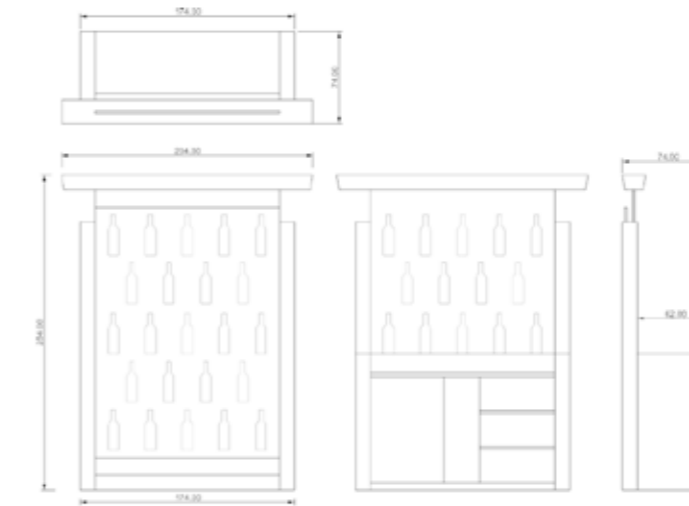

70.09  
 L 204 P 74 H 254 cm  
 f74 NERO LISCIO +  
 f85 CANALETTO

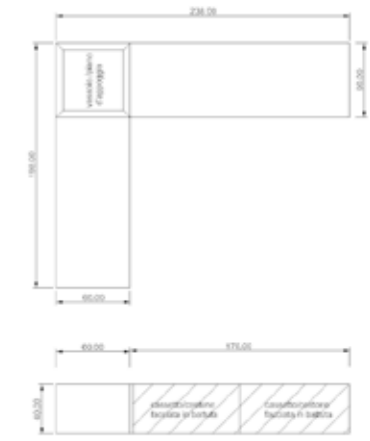

53.12 - PANCA CONTENITIVA  
 L 198+238 P 60 H 47 cm  
 f85 CANALETTO  
 fg.27 TESSUTO

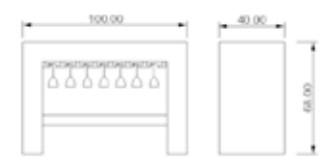

70.04  
 L 100 P 40 H 68 cm  
 f74 NERO LISCIO  
 f85 CANALETTO

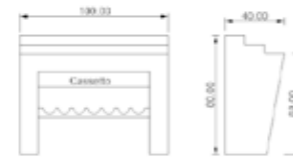

70.05  
 L 100 P 40 H 80 cm  
 f74 NERO LISCIO  
 f85 CANALETTO



70.06  
 L 100 P 7 H 80 cm  
 f85 CANALETTO



70.07  
 L 50 P 7 H 80 cm  
 f74 NERO LISCIO

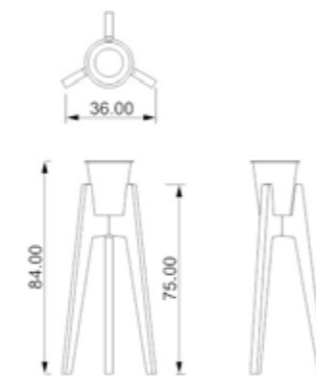

12.64  
 L 36 P 36 H 75 HB 84 cm  
 f85 CANALETTO

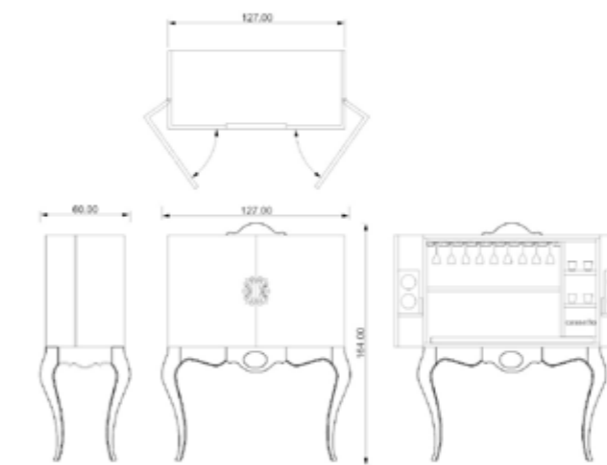

25.22  
 L 127 P 60 H 164 cm  
 f65 NOCE NERO

oppure...  
 or...

IL TUO PROGETTO  
 YOUR DESIGN





*Anteprima Catalogo Progettazione 2.0:  
Le cucine di Tosato*



*Bespoke Furnitures Catalogue preview 2.0:  
Tosato's kitchen!*

*Una cucina completa di tutto  
A kitchen complete with everything*

*Vani illuminati  
Illuminated compartments*



*Realizziamo ciò che desideri  
We do what you desire*

*Design unico e tecnologia moderna  
Unique design and modern technology*

*Dettagli e rifiniture  
Details and finishes*

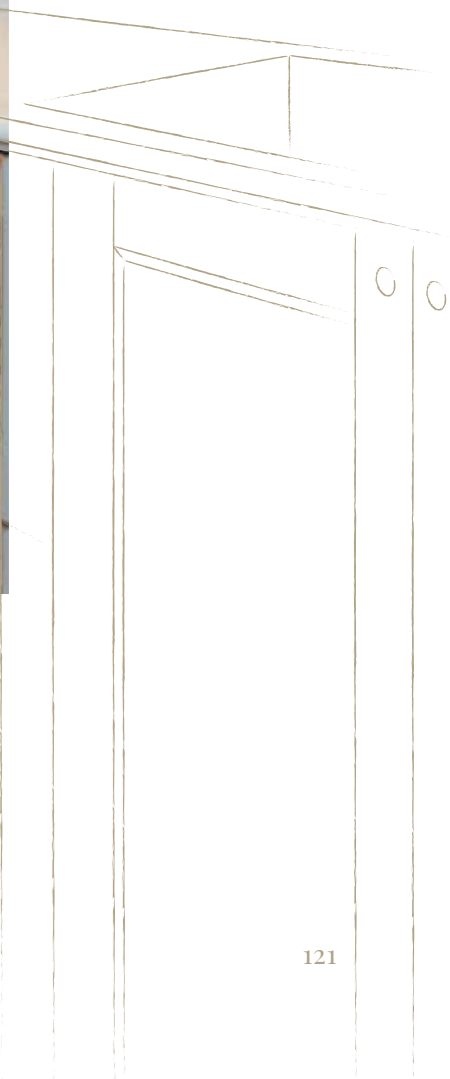



*Scegli i optional*  
*Choose your optional*



*Scegli la decorazione*  
*Chose you decoration*

*Completa la tua cucina  
Complete your kitchen*

*Carta da parati  
personalizzata  
Personalized  
wallpaper and wood  
pannelling*



*Boiserie  
Boiserie*

*Dettagli in oro  
Gold details*



*...scopri il seguito:  
cucine classiche e moderne!  
... discover the sequel:  
classic and modern kitchens!*



## Customize

*Puoi scegliere tra i nostri modelli, combinare vari stili...  
You can choose from our models, combine various styles...*

*...o chiederci un progetto sulla base della tua idea  
... or ask us for a project based on your idea Or send us your idea.*

*Abbina l'anta a tuo piacere  
Door and drawer styles wood or glass*

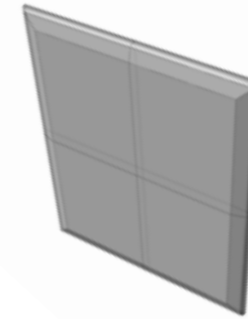

—  
ISTINTO

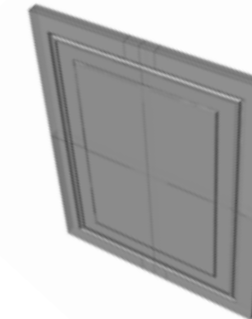

—  
ARIA

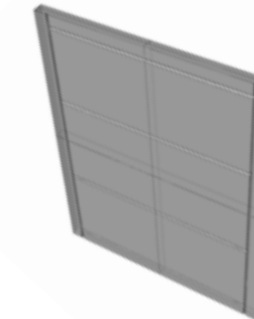

—  
LINEA

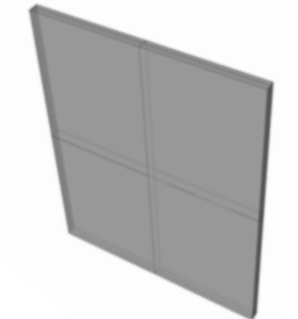

—  
MITO

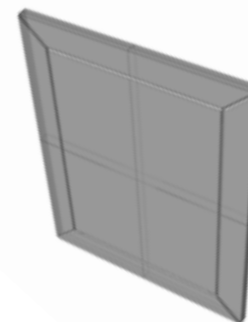

—  
METROPOLI

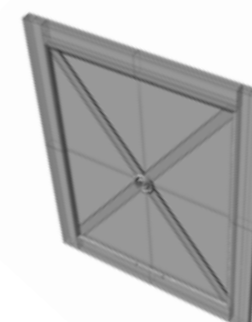

—  
DESIDERI

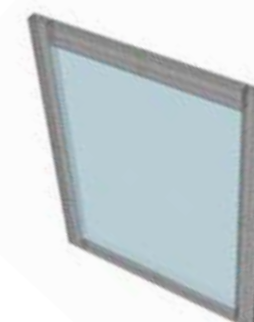

—  
IDEA

*oppure...  
or...*

**IL TUO PROGETTO  
YOUR DESIGN**



Aggiungi gli accessori alla tua libreria  
*Add accessories to your wall units*

Aggiungi gli accessori al tuo armadio  
*Add accessories to your closet*

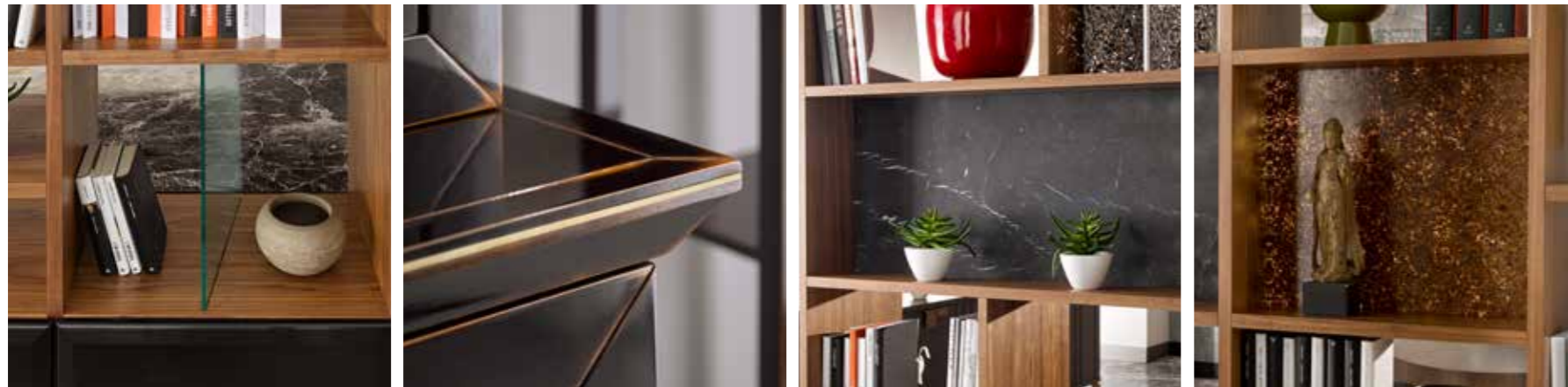

—  
 INSERTI CRISTALLO  
 GLASS INSERTS

—  
 INSERTI METALLO  
 METAL INSERTS

—  
 INSERTI MARMO  
 MARBLE INSERTS

—  
 INSERTI IN RESINA NATURALE  
 NATURAL RESIN INSERTS



—  
 SISTEMA SERVETTO  
 PULL-DOWN SYSTEM

—  
 PORTA PANTALONI ESTRAIBILE  
 PULL OUT TROUSER RAIL

—  
 PORTA SCARPE ESTRAIBILE  
 PULL OUT SHOE HOLDER

—  
 CASSETTI PORTA GIOIELLI  
 ACCESSORY DRAWER



—  
 SCHIENALI IMBOTTITI  
 QUILTED BACK PANEL

—  
 RIPIANI VETRO CON  
 STRUTTURA LEGNO  
 GLASS SHELVES WITH  
 WOOD FRAME

—  
 LED LIGHTING

oppure...  
 or...

IL TUO PROGETTO  
 YOUR DESIGN



—  
 SPECCHIO SU ANTA  
 MIRROR FOR DOOR

—  
 CASSETTIERA  
 CHEST OF DRAWERS

—  
 LED LIGHTING

oppure...  
 or...

IL TUO PROGETTO  
 YOUR DESIGN

Finiture opache o lucide  
 Finishings mat or glossy

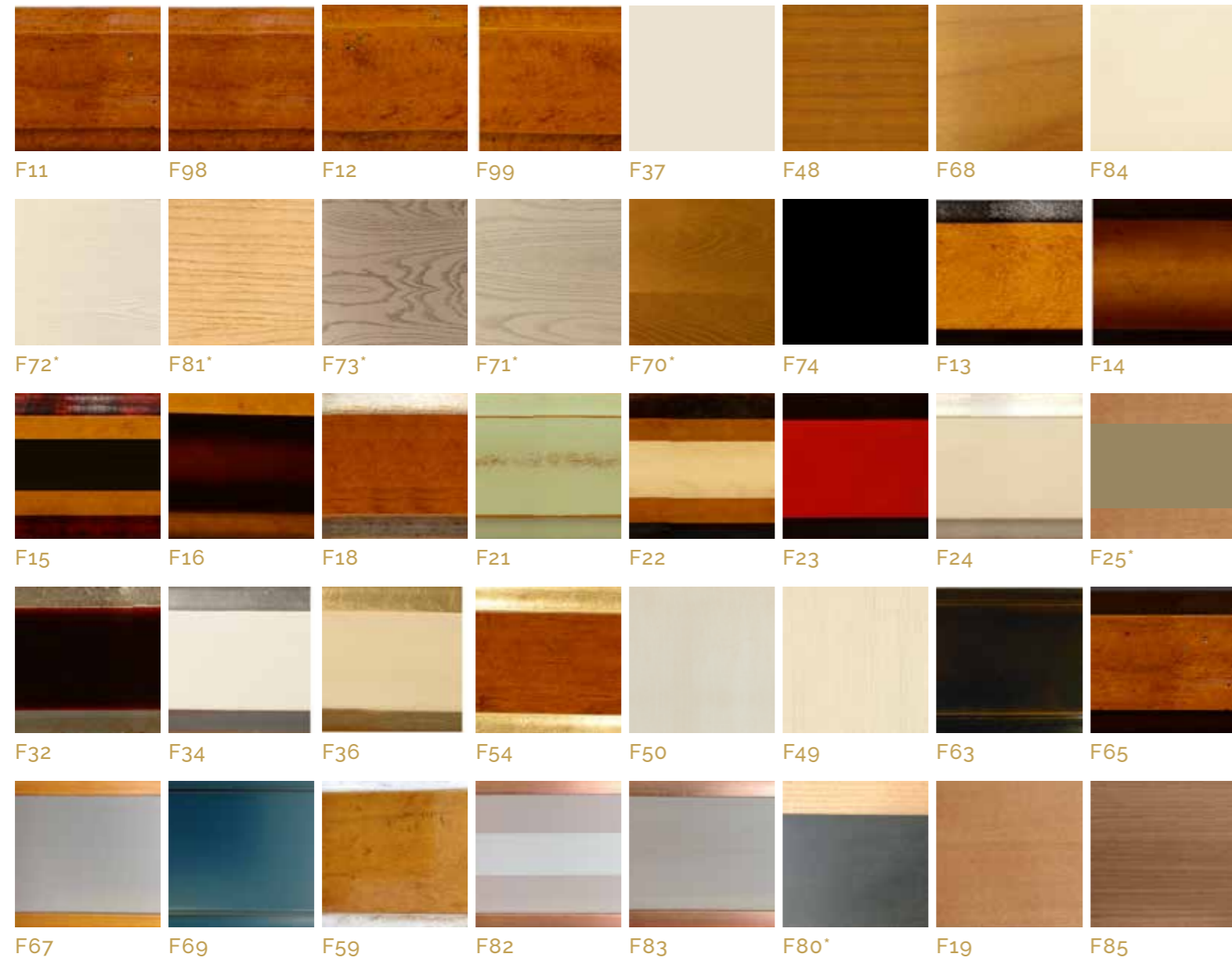

\*F70 - F71 - F72 - F73 - F81

Solo per: IL DESIDERIO D' AIDA  
 Only for: IL DESIDERIO D' AIDA

\*F80

Solo per: DOLCE VITA  
 Only for: DOLCE VITA



Tessuti e pelli  
 Fabrics and leathers





### *Marchio internazionale International brand*

Il marchio Tosato oltre ad una radicata presenza in Italia e in Europa continentale, ha sviluppato uno storico posizionamento nei mercati dell'Est Europa e dell'estremo oriente con particolare rilievo per la Sud Corea: in queste aree geografiche la grande "T" è sinonimo di "made in Italy" come dimostra la presenza di uno showroom mono marca nel centro di Seul.

*The Tosato brand in addition to a presence rooted in Italy and in continental Europe, has developed a historical located in the markets of Eastern Europe and the Far East with particular emphasis on the South Korea: in these geographical areas the great "T" is synonymous of "made in Italy" as evidenced by the presence of a single brand showroom in the center of Seoul.*

### *Tosato nel mondo Tosato in the world*

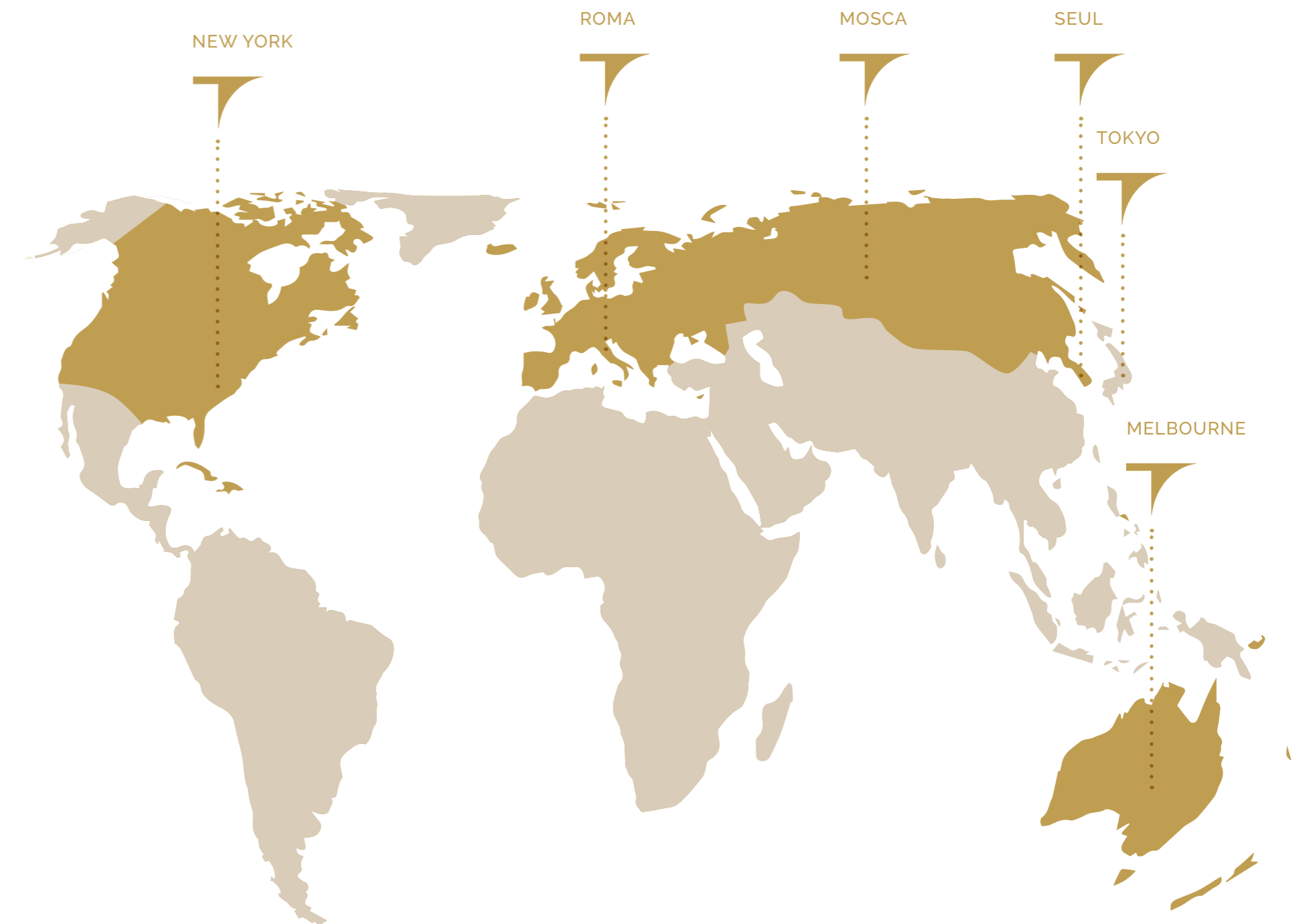





*Tosato srl*

---

*Via Masaccio, 8  
37053 Cerea (Verona) - Italy  
+39 0442 83333  
info@tosato.com*

---

*www.tosato.com*