

sound
collection



sound collection

design in movimento



PLUS:
Sistema con movimento
orizzontale della schiena e
variazione profondità
della seduta

System with horizontal movement of
the back and adjustable seat depth

Collezione che si esprime attraverso il linguaggio del comfort e del dinamismo. Il design diventa funzionale grazie ad un meccanismo che consente di vivere momenti di relax o di conversazione a seconda del posizionamento della schiena e la conseguente variazione della profondità della seduta.

Collection that expresses itself through the language of comfort and dynamism.

Design becomes functional thanks to a mechanism which allows for experiencing moments of relaxation or conversation, depending on the positioning of the back and the consequent adjustment of the seat depth.

pag. 04 **harmòny**

pag. 44 informazioni tecniche



pag. 22 **mèlody**

pag. 46 informazioni tecniche

harmòny

Il design è minimal.

Un approccio contemporaneo che stravolge gli standard e racconta la vostra personalità.

The design is minimal.

A contemporary approach that alters the standards and defines your personality.





harmòny

Divano laterale cm 190 sx e penisola angolare con pouff e con schiena 45° cm 225 dx. Piede Jump finitura manganese. Cinque cuscini cm 55x30 e un cuscino cm 50x50.

190 cm left sided sofa and 225 cm right sided corner chaise with pouff and with 45° back. Jump feet in manganese finish. Five 55x30 cushions and one 50x50 cm cushion.

sound collection



harmòny

Divano laterale cm 190 sx e penisola angolare
con pouff e con schiena 45° cm 225 dx.
Piede Jump finitura manganese.
Un cuscino cm 55x30.

190 cm left sided sofa and 225 cm right sided
corner chaise with pouf and with 45° back.
Jump feet in manganese finish.
One 55x30 cm cushion.

Dettagli che
svelano un animo
raffinato dalla
forte connotazione
contemporanea.

Details that reveal a
refined essence with a
strong contemporary
connotation.



sound collection



harmòny

Divano cm 300.
Piede Jump finitura cromo.
Due braccioli Roll e due cuscini cm 55x30.

300 cm sofa.
Jump feet in chrome finish.
Two Roll armrests and
two 55x30 cm cushions.

sound collection





harmòny

Divano laterale cm 190 sx e
penisola angolare con pouff e
con Even colore beige dx.
Tre cuscini cm 55x30.

190 cm left sided sofa and right sided
corner chaise with pouf and Even in beige.
Three 55x30 cm cushions.

sound collection



harmòny

Divano laterale cm 190 sx e penisola angolare con pouff dx.
Due braccioli Tune.
Un cuscino cm 50x50, un cuscino cm 40x40 e un cuscino cm 55x30.

190 cm left sided sofa and right sided corner chaise with pouf. Two Tune armrests.
One 50x50 cm cushion, one 40x40 cm cushion and one 55x30 cm cushion.



harmòny

Elementi innovativi che diventano dettagli distintivi. Comodità e praticità trovano qui la giusta espressione.

Innovative elements that become distinctive details. Comfort and convenience discover the right form of expression.



sound collection



harmòny

Divano cm 240.
Piede Frame finitura manganese.
Un bracciolo Tune.
Un cuscino cm 55x30.

240 cm sofa.
Frame feet in manganese finish.
One Tune Armrest.
One 55x30 cm cushion.

sound collection



harmòny

Divano laterale cm 190 sx e panchetta dx.
Piede Frame finitura grigio.
Due braccioli Roll.
Due cuscini cm 55x30.

190 cm left sided sofa and right sided
bench. Frame feet in grey finish.
Two Roll armrests.
Two 55x30 cm cushions.

mélody

Il relax trova la sua forma
perfetta elevando il binomio
comfort e design.

Relaxation finds its perfect form of
expression by elevating the combination of
comfort and design.





mèlody

Divano cm 290.
Piede Frame finitura grigio.
Due cuscini cm 50x50,
un cuscino cm 40x40 e
due cuscini cm 55x30.

290 cm sofa.
Frame feet in grey finish.
Two 50x50 cushions, one 40x40 cm
cushion and two 55x30 cushions.

sound collection



mèlody

Divano laterale cm 185 sx e penisola angolare con pouff e con Even colore nero dx. Piede Jump finitura cromo. Un cuscino cm 50x50, un cuscino cm 40x40 e tre cuscini cm 55x30.

185 cm left sided sofa and right sided corner chaise with pouff and Even in black. Jump feet in chrome finish. One 50x50 cushion, one 40x40 cm cushion and three 55x30 cushions.



mèlody

Estrema cura nella definizione di ogni dettaglio. Risposte puntuali alle nuove esigenze estetiche.

Extreme care in the definition of every detail.
Timely solutions for the latest aesthetic requirements.



sound collection



mèlody

Divano laterale cm 185 sx e penisola angolare con pouff e con Even colore nero dx.
Piede Jump finitura cromo.
Tre cuscini cm 55x30.

185 cm left sided sofa and right sided corner chaise with pouf and Even in black.
Jump feet in chrome finish.
Three 55x30 cm cushions.

sound collection



mèlody

Divano cm 230.
Piede Frame finitura manganese.
Un cuscino cm 50x50 e
un cuscino cm 55x30.

230 cm sofa.
Frame feet in manganese finish.
One 50x50 cm cushion and
one 55x30 cm cushion.

sound collection



mèlody

**La leggerezza
strutturale e
compositiva conquista
lo spazio traducendosi
in comodità e cultura
del presente.**

The structural and compositional
lightness conquers the space,
translating into comfort and culture
characteristic of the present.



sound collection



mèlody

Centrale cm 80 e angolo
con bracciolo cm 235 dx.
Un cuscino cm 50x50, un cuscino
cm 40x40 e tre cuscini cm 55x30.

80 cm central section 235 cm right sided
corner section with armrest.
One 50x50 cushion, one 40x40 cm cushion
and three 55x30 cushions.



mèlody

Centrale cm 80 e angolo
con bracciolo cm 235 dx.
Un cuscino cm 40x40 e
un cuscino cm 55x30.

80 cm central section 235 cm right sided
corner section with armrest.
One 40x40 cm cushion and
one 55x30 cushion.



mèlody

Divano laterale cm 185 sx e panchetta dx.
Piede Jump finitura manganese.
Un cuscino cm 50x50,
un cuscino cm 40x40 e
un cuscino cm 55x30.

185 cm left sided sofa and right sided bench.
Jump feet in manganese finish.
One 50x50 cm cushion, one 40x40 cm
cushion and one 55x30 cm cushion.

Comode sedute e
poggiatesta regolabili
raccontano forma e
funzione. Tutto in
perfetto equilibrio.

Comfortable seating and
adjustable headrests
portray form and
function.
All in perfect balance.



sound collection



mèlody

Divano laterale cm 185 sx e panchetta dx.
Piede Jump finitura manganese.
Un cuscino cm 50x50, un cuscino cm 40x40,
un cuscino cm 55x30 e un cuscino poggiatesta.

185 cm left sided sofa and right sided bench.
Jump feet in manganese finish.
One 50x50 cm cushion, one 40x40 cm cushion,
one 55x30 cm cushion and
one headrest cushion.

sound collection

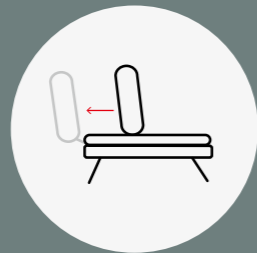

PLUS:
Sistema con movimento
orizzontale della schiena e
variazione profondità
della seduta
System with horizontal movement of
the back and adjustable seat depth

Informazioni Tecniche

Technical Sheet

harmòny

divani/elementi

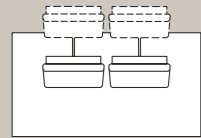
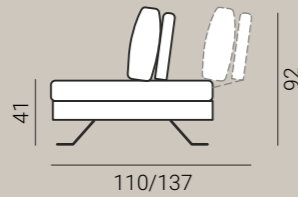

DIVANO
L 200 P 110/137 H 92

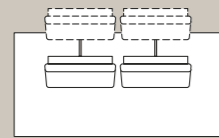

DIVANO
L 220 P 110/137 H 92

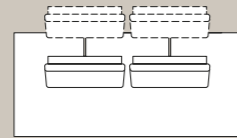

DIVANO
L 240 P 110/137 H 92

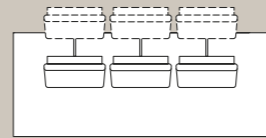

DIVANO
L 270 P 110/137 H 92

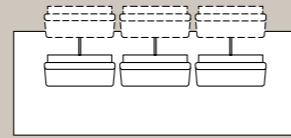

DIVANO
L 300 P 110/137 H 92

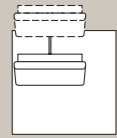

POLTRONA
LATERALE DX/SX
L 110 P 110/137 H 92

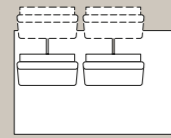

DIVANO
LATERALE DX/SX
L 170 P 110/137 H 92

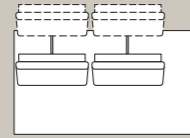

DIVANO
LATERALE DX/SX
L 190 P 110/137 H 92

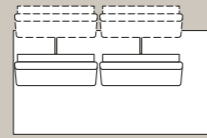

DIVANO
LATERALE DX/SX
L 210 P 110/137 H 92



CENTRALE
L 80 P 110/137 H 92

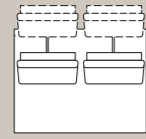

CENTRALE
L 140 P 110/137 H 92

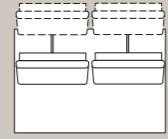

CENTRALE
L 160 P 110/137 H 92

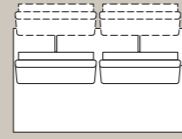

CENTRALE
L 180 P 110/137 H 92

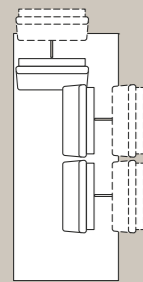

PENISOLA ANGOLARE
C/POUFF DX/SX
L 110/137 P 240/267 H 92

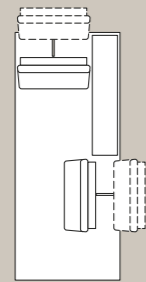

PENISOLA ANGOLARE
C/POUFF E C/EVEN DX/SX
L 110/137 P 240/267 H 92

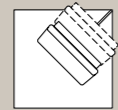

ANGOLO RETTO
C/ SCHIENA 45°
L 110 /120 P 110/120 H 92

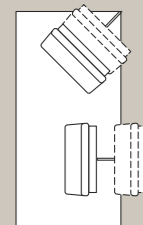

PENISOLA ANGOLARE
C/POUFF
C/SCHIENA 45° DX/SX
L 110/137 P 225/235 H 92

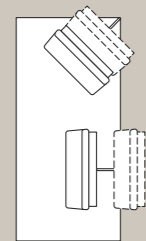

PENISOLA ANGOLARE
C/POUFF
C/SCHIENA 45° DX/SX
L 110/137 P 235/245 H 92

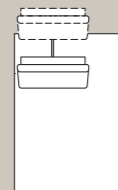

PANCHETTA DX/SX
L 110 P 165/192 H 92

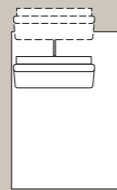

PANCHETTA MAXI
DX/SX
L 120 P 165/192 H 92



POUFF
L 110 P 110 H 41



POUFF
L 80 P 60 H 41



CUSCINO
L 40 X 40



CUSCINO
L 50 X 50



CUSCINO
L 55 X 30



CUSCINO POGGIATESTA
L 55 X 30

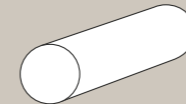

BRACCIOLO ROLL
Ø 22 P 92

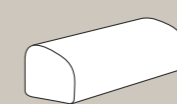

BRACCIOLO TUNE
L 28 P 92 H 18

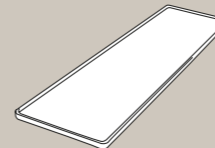

ACCESSORIO EVEN
L 34 x 125

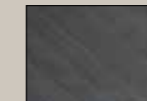

Finitura nera
di serie.

Standard black finishes.

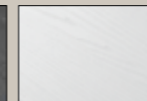

Finitura bianca
optional.

Optional white finishes.

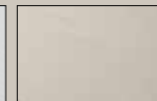

Finitura beige
optional.

Optional beige finishes.



Piede Zed finitura cromo
di serie.
Manganese **optional.**

*Zed feet in chrome finish as **standard.** Optional manganese finish.*



Piede Jump finitura cromo o manganese
optional.

*Jump feet in chrome finish or in **optional** manganese finish.*



Piede Frame finitura grigio o manganese
optional.

*Frame feet in grey finish or in **optional** manganese finish.*

mèlody

divani/elementi

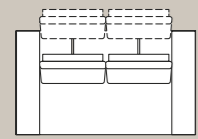
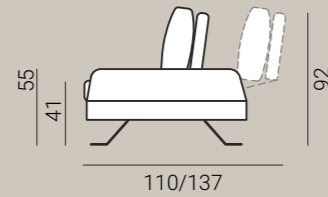

DIVANO
L 190 P 110/137 H 92

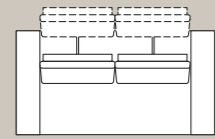

DIVANO
L 210 P 110/137 H 92

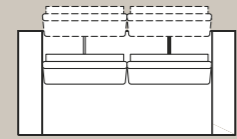

DIVANO
L 230 P 110/137 H 92

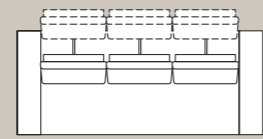

DIVANO
L 260 P 110/137 H 92

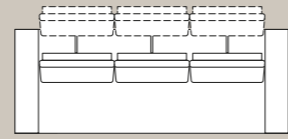

DIVANO
L 290 P 110/137 H 92

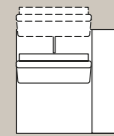

POLTRONA
LATERALE DX/SX
L 105 P 110/137 H 92

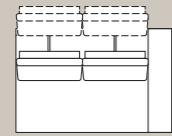

DIVANO
LATERALE DX/SX
L 165 P 110/137 H 92

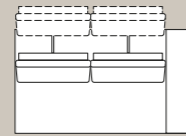

DIVANO
LATERALE DX/SX
L 185 P 110/137 H 92

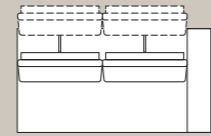

DIVANO
LATERALE DX/SX
L 205 P 110/137 H 92



CENTRALE
L 80 P 110/137 H 92

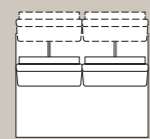

CENTRALE
L 140 P 110/137 H 92

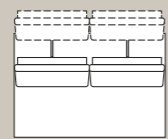

CENTRALE
L 160 P 110/137 H 92

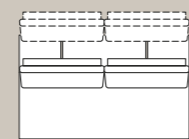

CENTRALE
L 180 P 110/137 H 92

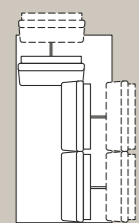

PENISOLA ANGOLARE
DX/SX
L 110/137 P 210/237 H 92

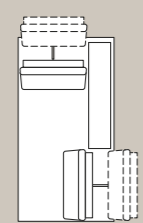

PENISOLA ANGOLARE
C/EVEN DX/SX
L 110/137 P 210/237 H 92

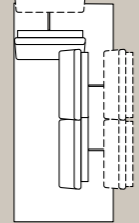

PENISOLA ANGOLARE
C/POUFF DX/SX
L 110/137 P 240/267 H 92

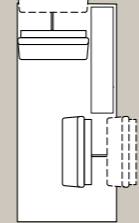

PENISOLA ANGOLARE
C/POUFF E C/EVEN DX/SX
L 110/137 P 240/267 H 92

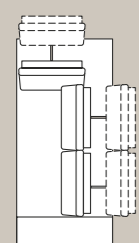

ANGOLO
C/BRACCIOLO DX/SX
L 110/137 P 235/262 H 92

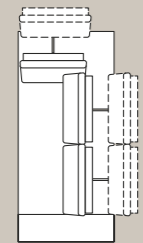

ANGOLO
C/BRACCIOLO DX/SX
L 110/137 P 245/272 H 92

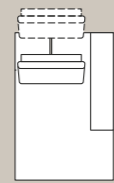

PANCHETTA DX/SX
L 105 P 165/192 H 92



PANCHETTA MAXI
DX/SX
L 115 P 165/192 H 92



POUFF
L 110 P 110 H 41



POUFF
L 80 P 60 H 41



CUSCINO
L 40 X 40



CUSCINO
L 50 X 50



CUSCINO
L 55 X 30



CUSCINO POGGIATESTA
L 55 X 30

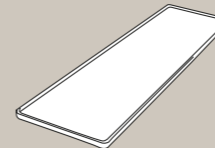

ACCESSORIO EVEN
L 34 x 125

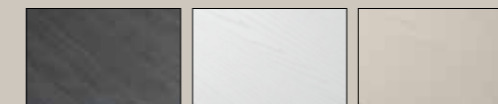

Finitura nera
di serie.

Standard black
finishes.

Finitura bianca
optional.

Optional white
finishes.

Finitura beige
optional.

Optional beige
finishes.



Piede Zed finitura cromo
di serie.
Manganese **optional.**

Zed feet in chrome finish
as **standard.**
Optional manganese
finish.



Piede Jump finitura
cromo o manganese
optional.

Jump feet in chrome
finish or in **optional**
manganese finish.



Piede Frame finitura
grigio o manganese
optional.

Frame feet in grey
finish or in **optional**
manganese finish.

harmòny / mèlody

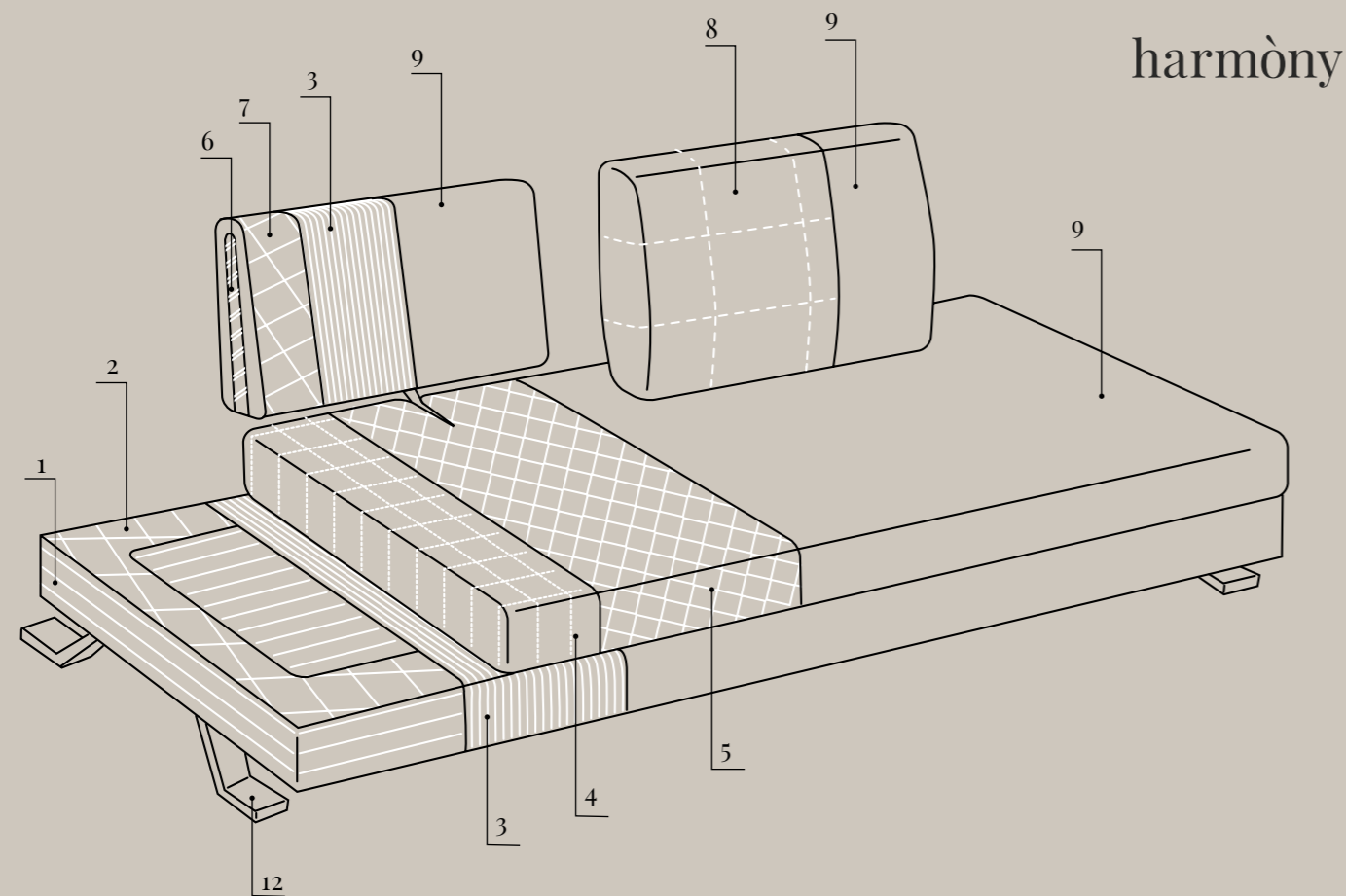

harmòny

Bracciolo
Harmòny
Roll

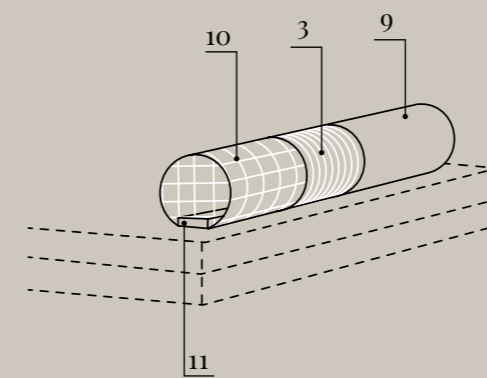

Bracciolo
Harmòny
Tune

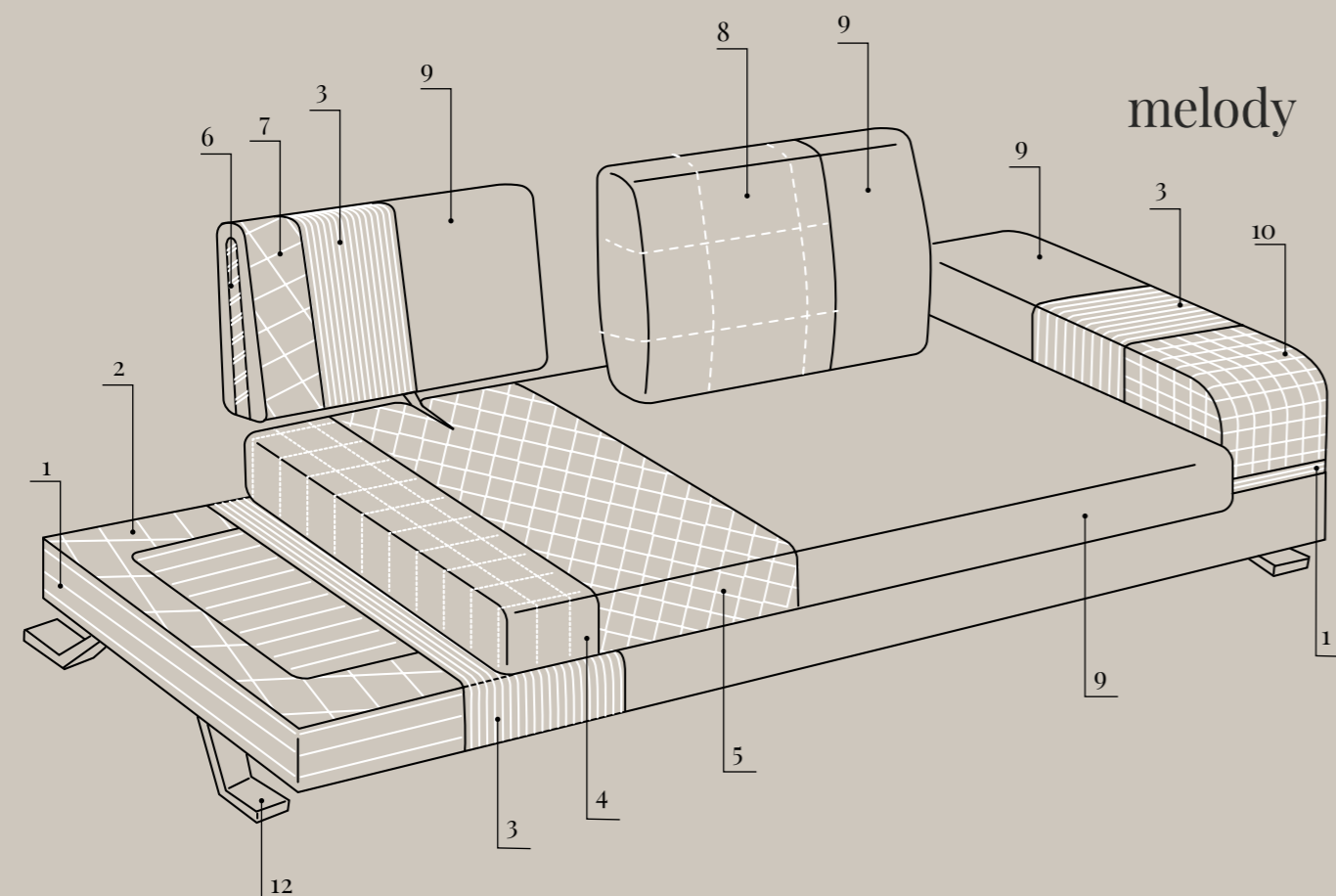
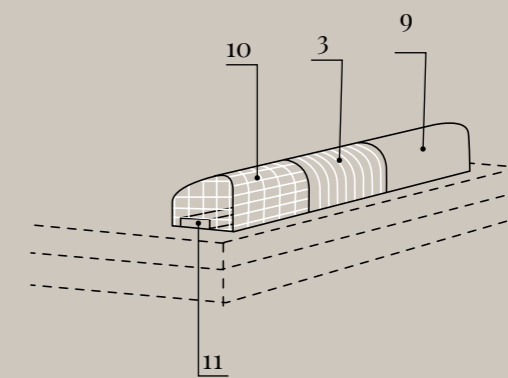

mèlody

Legenda

1. Struttura in legno stagionato e agglomerato
Structure in seasoned and bonded wood.
2. Imbottitura in poliuretano espanso indeformabile PK40.
Padding in PK40 non-deformable polyurethane foam.
3. Vellutino accoppiato a fibra di poliestere gr 300.
Velveteen bonded to 300 g polyester fibre.
4. Cuscino seduta in poliuretano espanso indeformabile D40 morbido.
Seat cushion in soft D40 non-deformable polyurethane foam.
5. Rivestimento in ovatta di poliestere gr 300.
Lining in 300 g polyester wadding.
6. Struttura e meccanismo per movimento orizzontale della schiena in acciaio.
Structure and mechanism for horizontal movement of the back in steel.
7. Imbottitura in poliuretano espanso indeformabile D30.
Padding in D30 non-deformable polyurethane foam.
8. Cuscino schienale in mollapiuma canalizzata (piuma d'oca e fibra di poliestere).
Back cushion in mixed channelled filling (goose down and polyester fibre).
9. Rivestimento completamente sfoderabile in tessuto, parzialmente sfoderabile in pelle o ecopelle.
Fully removable upholstery in fabric, partially removable in leather or faux leather.
10. Bracciolo in poliuretano espanso indeformabile D30.
Armrest in D30 non-deformable polyurethane foam.
11. Barra in metallo.
Metal bar.
12. Piede Zed di serie, Jump e Frame optional.
Zed feet as standard, Jump and Frame model feet optional.

harmòny



mèlody

Elementi innovativi che
diventano dettagli distintivi

SAMOA SRL

31014 Colle Umberto (TV) - ITALY
Via I° Maggio, 9/11 (Z.I.)

Tel. +39 0438 388179
Fax +39 0438 430482

www.samoativani.com
www.bsideletti.it
info@samoativani.com

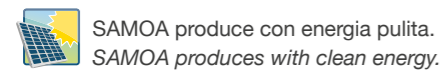

CREDITS:

Style
Centro stile Samoa, Treviso

Concept, Graphic design
Neiko, Treviso

Images
Neiko, Treviso

Print
Grafiche Antiga



SAMOA[®]
DIVANI E IMBOTTITI

slide
collection

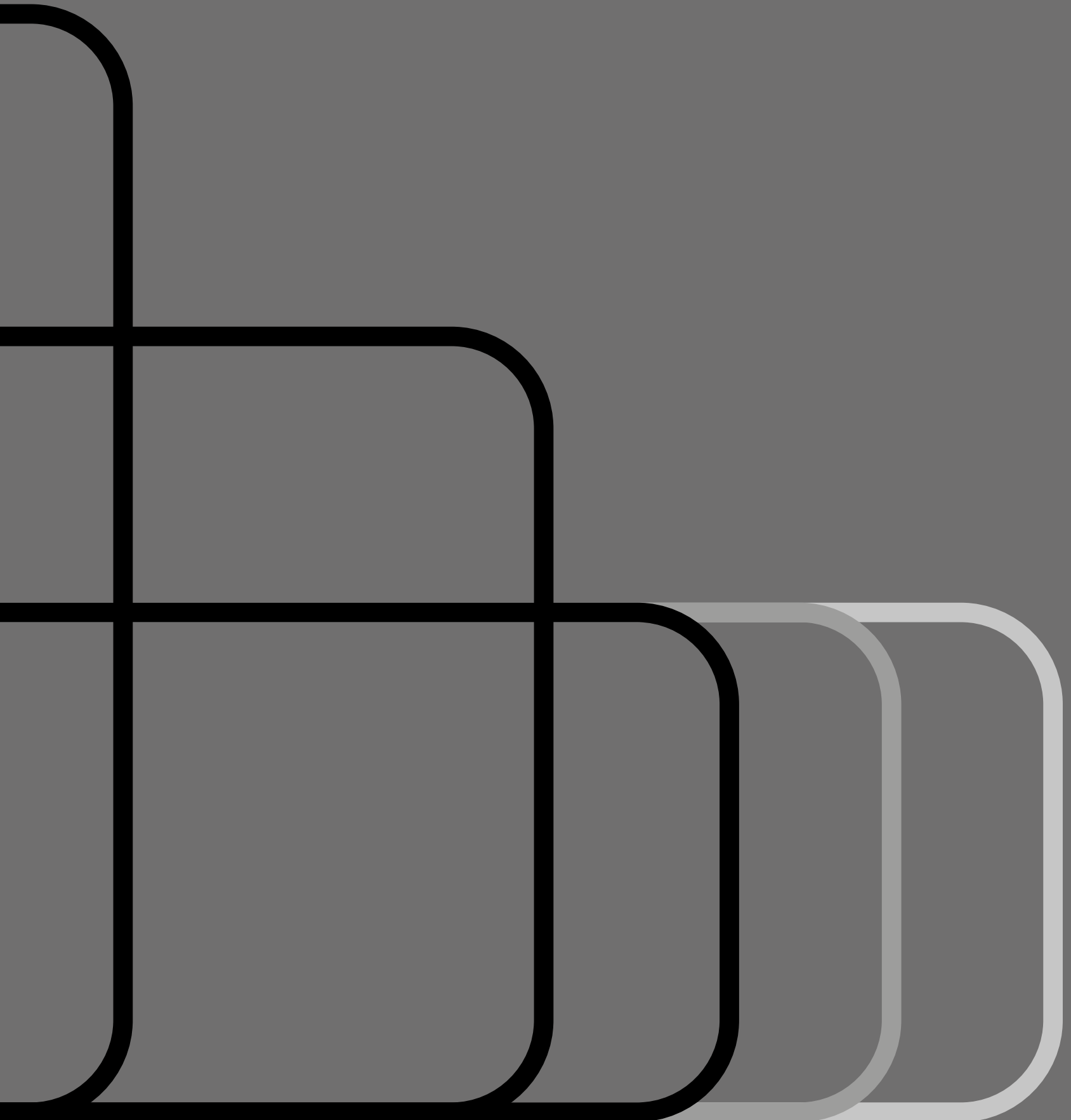

L'indiscusso prestigio
di una raffinata eleganza



SLIDE
collection



SLIDE collection:

10 24 30 32 34 36 drive FINITURA NORMALE

14 22 drop FINITURA VINTAGE

08 18 20 shift FINITURA NORMALE

12 26 stream FINITURA VINTAGE

STILE, DIVERSITA' E CAMBIAMENTO

Unione armonica di forme e funzione:
questa è SLIDE, la nuova collezione,
tutta da scoprire, firmata Samoa.

La sua tecnologia innovativa consente di
sviluppare il massimo comfort, per creare
un piacere che non conosce compromessi.



DIM. 215 x 108 cm

La scelta dei poggiatesta su tutti i modelli della collezione permette combinazioni esclusive, piccoli dettagli che fanno la differenza per un comfort assoluto.



DIM. 215 x 108 cm
con seduta semiaperta + cm. 20
con seduta completamente aperta + cm. 40

Anche nella versione componibile si percepisce la forza innovativa della collezione Slide. Le sedute estraibili trasformano in pochi istanti la forma dei divani ma, soprattutto, offrono generosi spazi di seduta, per un relax garantito.



DIM. 295 x 165 cm
con seduta semiaperta + cm. 20
con seduta completamente aperta + cm. 40



DROP - DIVANO LATERALE dx cm. 190 E PENISOLA ANGOLARE cm. 175
CON UN CUSCINO ARREDO cm. 55 x 55

drop

La collezione Slide consente, attraverso una vasta gamma di elementi aggiuntivi, il piacere di comporre nuovi concetti di tendenza. Rigore e creatività: il must è stupire con eleganza.



DIM. 295 x 175 cm

inedita bellezza

La prestigiosa qualità dei materiali
e la raffinatezza delle finiture,
con particolare cura di ogni singolo dettaglio,
esprimono il carattere deciso dei divani.

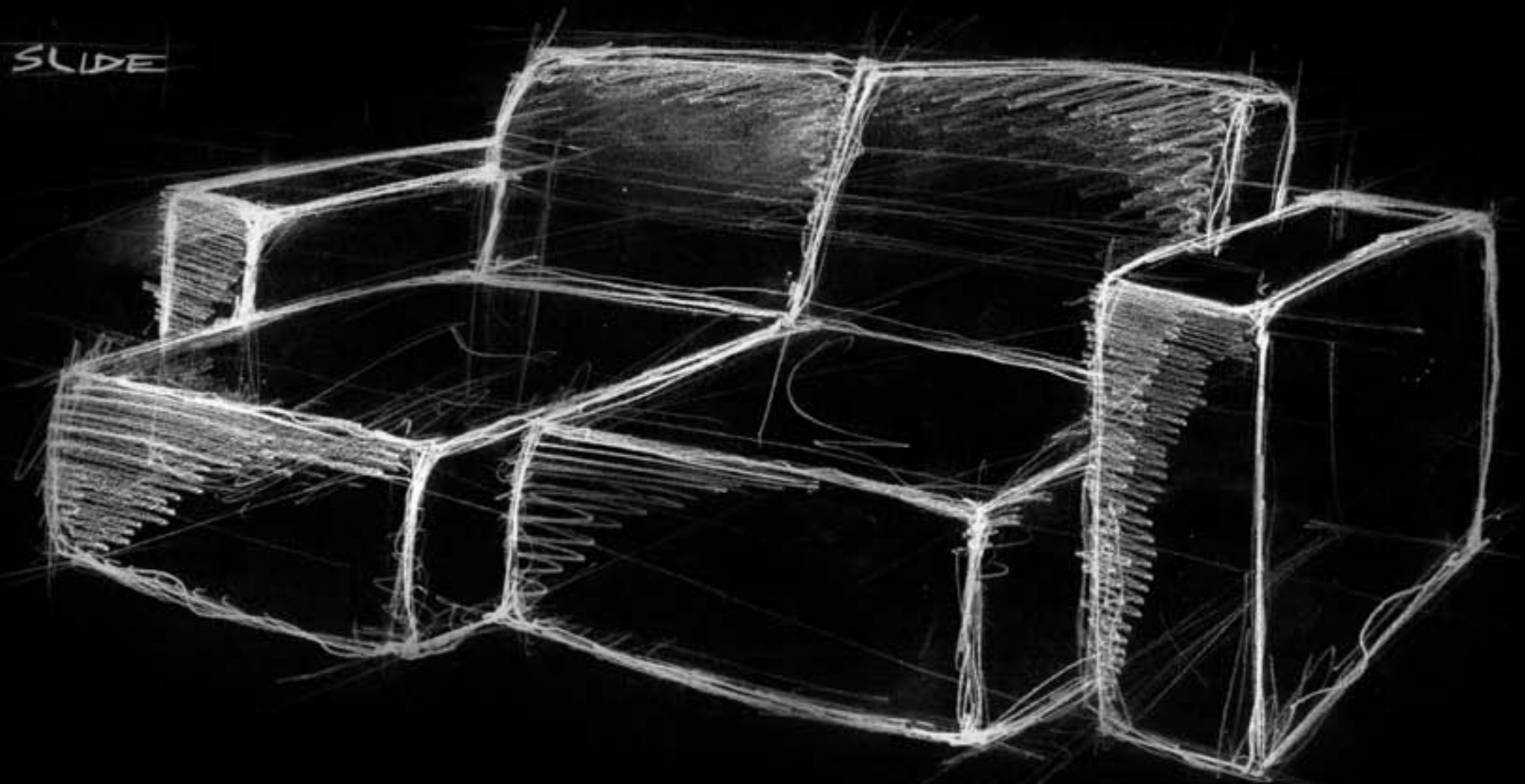

Slide è una collezione di divani che,
quando entra in scena, si riconosce subito,
anche per i suoi lati più nascosti.
Una bellezza che affascina e trasforma
ogni sguardo in un' esperienza unica.



Le penisole con bracciolo a libreria, oltre a valorizzare le composizioni,
rispondono ad esigenze di funzionalità e design.

Finiture di serie rovere moro, frassinato bianco su richiesta.



DIM. 275 x 238 cm



DIM. 275 x 238 cm

DROP - DIVANO cm. 235

Slide consente svariate combinazioni ed è adatta a tutte le situazioni di arredo.

Le sedute, proposte in diverse dimensioni e profondità, si accostano con estrema naturalezza, sfruttando al meglio gli spazi.

drop



DIM. 235 x 108 cm
con seduta semiaperta + cm. 20
con seduta completamente aperta + cm. 40

drive

DRIVE - DIVANO cm. 265

Nella collezione Slide la variabilità è una costante: l'innovativo meccanismo permette di estrarre le sedute con estrema facilità offrendo ben due diverse posizioni relax.

Il meccanismo è tutelato da deposito di brevetto.

DIM. 265 x 108 cm
con seduta semiaperta + cm. 20
con seduta completamente aperta + cm. 40



STREAM - DIVANO cm. 235
CON DUE CUSCINI ARREDO cm. 55 x 55

stream



DIM. 235 x 108 cm

spazio mutevole

Lo spazio diventa teatro di un nuovo
e naturale dinamismo: versatilità
e forme in movimento permettono
di arredare in libertà, regalando un piacere
inedito e sorprendente.

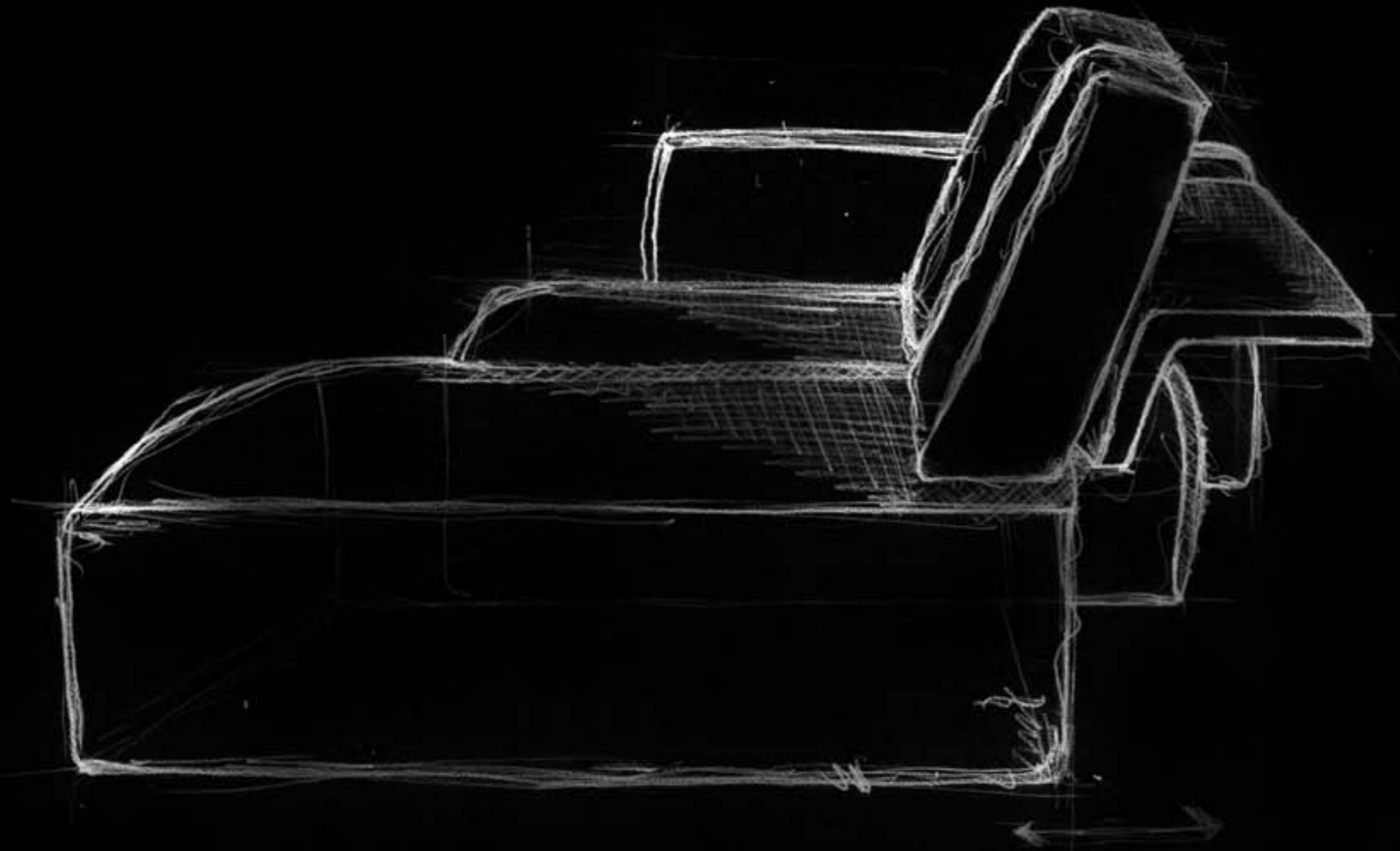





DRIVE - DIVANO LATERALE dx cm. 190 E PENISOLA ANGOLARE CON LIBRERIA sx cm. 195
CON UN CUSCINO BRACCIOLO

drive

Le penisole con bracciolo a libreria
uniscono estetica e praticità.

Vengono proposte di serie in finitura
rovere moro, frassinato bianco su richiesta.



DIM. 295 x 195 cm

DRIVE - COMPONIBILE PENISOLA sx
CON UN CUSCINO BRACCIOLO

drive

I componibili e i componibili con panchetta reversibile sono uno dei punti di forza della collezione Slide: si caratterizzano per i movimenti delle tre sedute e permettono di adattare il proprio relax a tutte le situazioni.

Il meccanismo è tutelato da deposito di brevetto.



DIM. 265 x 175 cm

DRIVE - COMPONENTE PENISOLA sx
CON UN CUSCINO BRACCIOLO

drive

Da ogni prospettiva è possibile riconoscere
la ricercatezza che contraddistingue Slide.

Questa sua connotazione la rende sempre
e assolutamente protagonista.

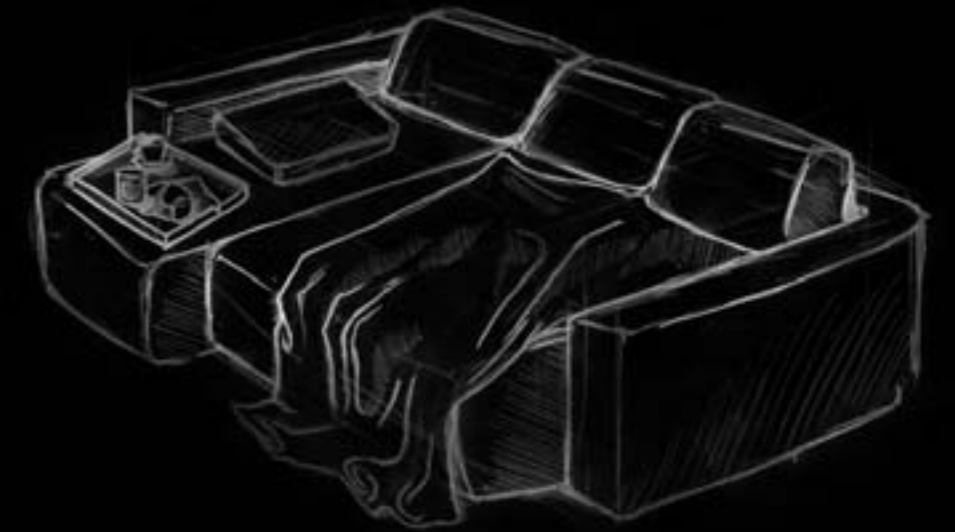

DIM. 265 x 175 cm
con seduta semiaperta + cm. 20
con seduta completamente aperta + cm. 40



TECNICAMENTE SLIDE

drive

drop

shift

stream

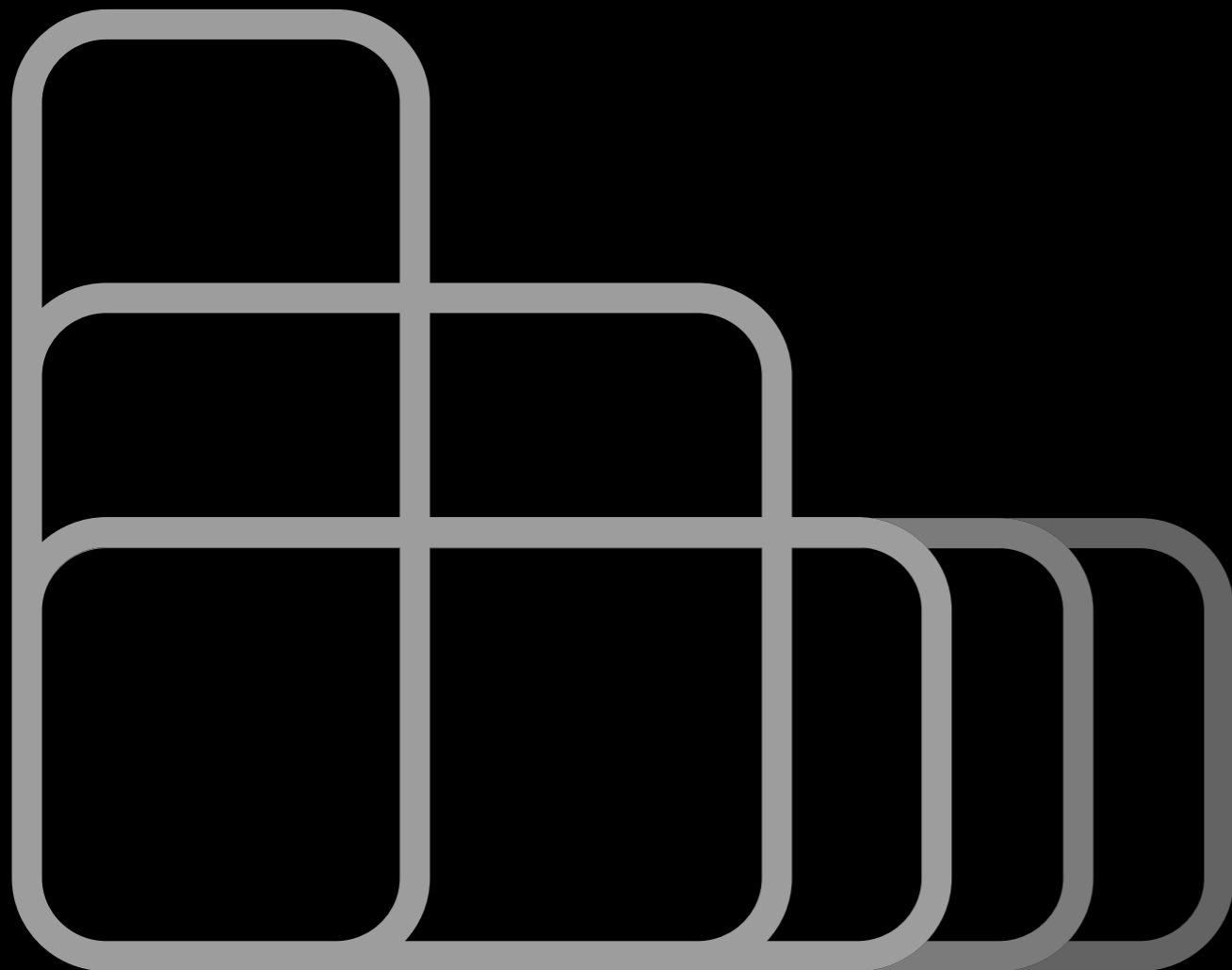

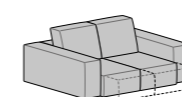
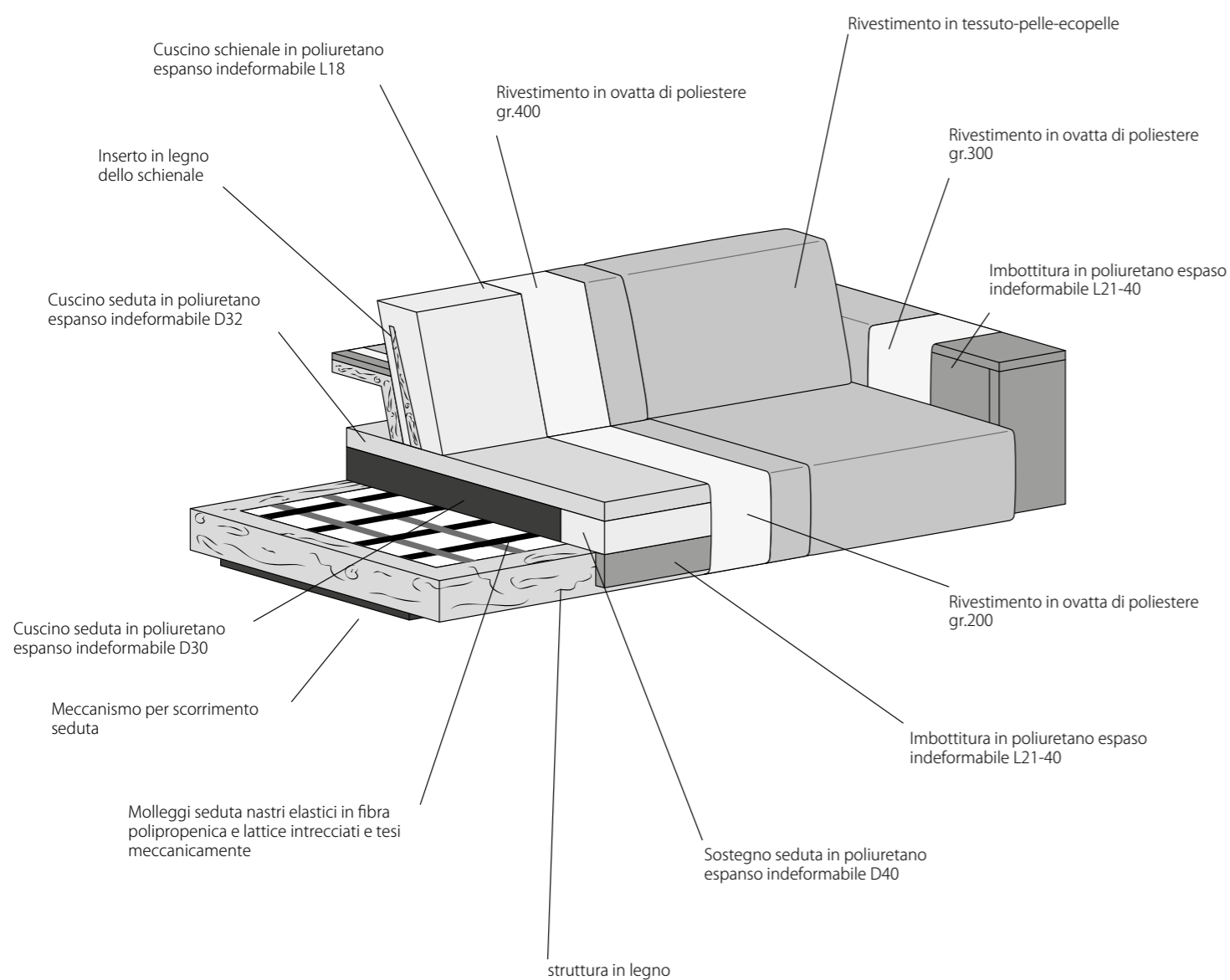

Divano
L 175 P 108 H 82

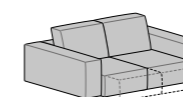

Divano
L 195 P 108 H 82

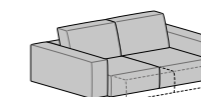

Divano
L 215 P 108 H 82

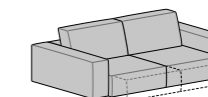

Divano
L 235 P 108 H 82

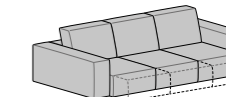

Divano
L 265 P 108 H 82

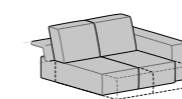

Divano laterale Dx-Sx
L 150 P 108 H 82

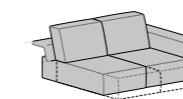

Divano laterale Dx-Sx
L 170 P 108 H 82

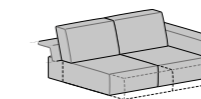

Divano laterale Dx-Sx
L 190 P 108 H 82

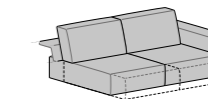

Divano laterale Dx-Sx
L 210 P 108 H 82

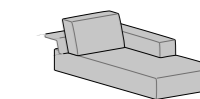

Panchetta laterale Dx-Sx
L 105 P 165 H 82



Penisola angolare Dx-Sx
L 105 P 175 H 82



Penisola angolare Dx-Sx
L 105 P 195 H 82



Penisola angolare Dx-Sx
L 105 P 215 H 82

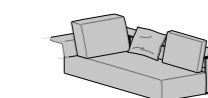

Penisola angolare con libreria Dx-Sx
L 105 P 175 H 82

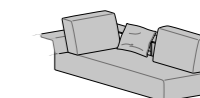

Penisola angolare con libreria Dx-Sx
L 105 P 195 H 82

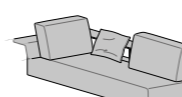

Penisola angolare con libreria Dx-Sx
L 105 P 215 H 82

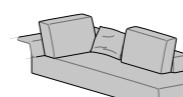

Penisola angolare con pouff Dx-Sx
L 105 P 218 H 82

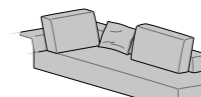

Penisola angolare con pouff Dx-Sx
L 105 P 238 H 82

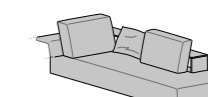

Penisola angolare con pouff e libreria Dx-Sx
L 105 P 218 H 82

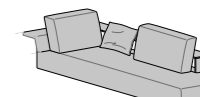

Penisola angolare con pouff e libreria Dx-Sx
L 105 P 238 H 82

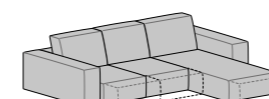

Componibile panchetta reversibile
L 265 P 165 H 82

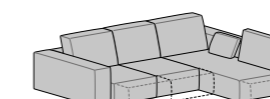

Componibile penisola Dx-Sx
L 265 P 175 H 82

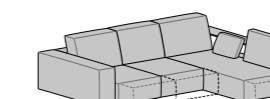

Componibile penisola con libreria Dx-Sx
L 265 P 175 H 82



Cuscino bracciolo
50x50



Cuscino Arredo
55 x 55

SFODERABILITA'

Completamente sfoderabile nella versione tessuto, parzialmente sfoderabile nelle versioni pelle ed ecopelle.

COMPLEMENTI IN LEGNO

Di serie finitura rovere moro, optional frassinato bianco.

VERSIONE LETTO

Non prevista.



Poggiatesta
60 x 12



Poggiatesta
70 x 12



Poggiatesta
80 x 12



Poggiatesta
90 x 12

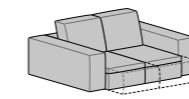
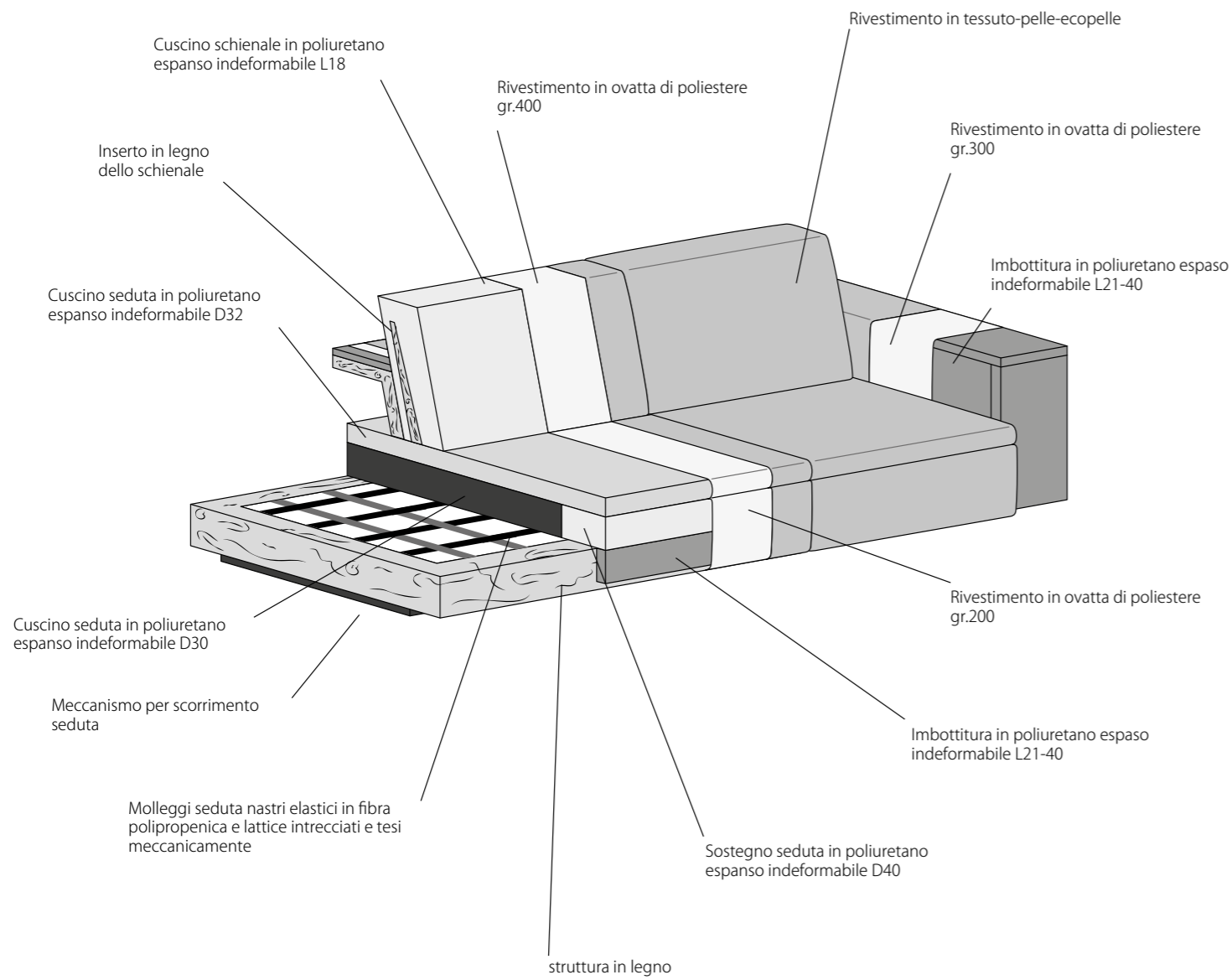

Divano
L 175 P 108 H 82

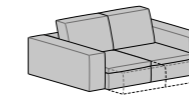

Divano
L 195 P 108 H 82

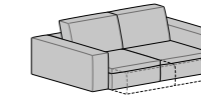

Divano
L 215 P 108 H 82

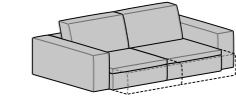

Divano
L 235 P 108 H 82

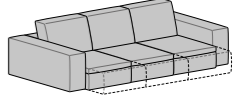

Divano
L 265 P 108 H 82

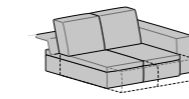

Divano laterale Dx-Sx
L 150 P 108 H 82

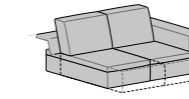

Divano laterale Dx-Sx
L 170 P 108 H 82

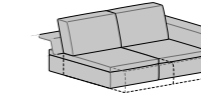

Divano laterale Dx-Sx
L 190 P 108 H 82

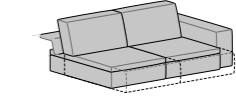

Divano laterale Dx-Sx
L 210 P 108 H 82

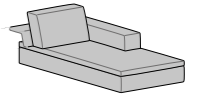

Panchetta laterale Dx-Sx
L 105 P 165 H 82

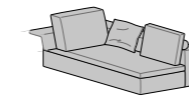

Penisola angolare Dx-Sx
L 105 P 175 H 82



Penisola angolare Dx-Sx
L 105 P 195 H 82



Penisola angolare Dx-Sx
L 105 P 215 H 82

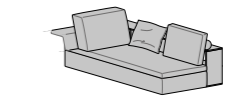

Penisola angolare con libreria Dx-Sx
L 105 P 175 H 82

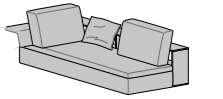

Penisola angolare con libreria Dx-Sx
L 105 P 195 H 82

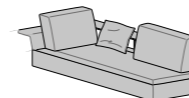

Penisola angolare con libreria Dx-Sx
L 105 P 215 H 82

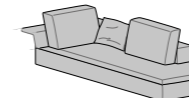

Penisola angolare con pouff Dx-Sx
L 105 P 218 H 82



Penisola angolare con pouff Dx-Sx
L 105 P 238 H 82

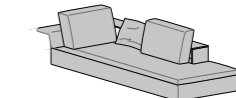

Penisola angolare con pouff e libreria Dx-Sx
L 105 P 218 H 82

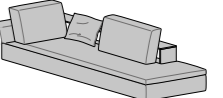

Penisola angolare con pouff e libreria Dx-Sx
L 105 P 238 H 82

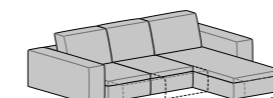

Componibile panchetta reversibile
L 265 P 165 H 82

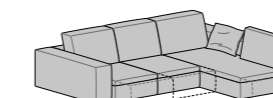

Componibile penisola Dx-Sx
L 265 P 175 H 82

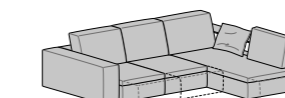

Componibile penisola con libreria Dx-Sx
L 265 P 175 H 82



Cuscino bracciolo
50x50



Cuscino Arredo
55 x 55

SFODERABILITA'

Completamente sfoderabile nella versione tessuto, parzialmente sfoderabile nelle versioni pelle ed ecopelle.

COMPLEMENTI IN LEGNO

Di serie finitura rovere moro, optional frassinato bianco.

VERSIONE LETTO

Non prevista.



Poggiatesta
60 x 12



Poggiatesta
70 x 12



Poggiatesta
80 x 12



Poggiatesta
90 x 12



spazio
mutevole



inedita
bellezza



stile, diversità
e cambiamento

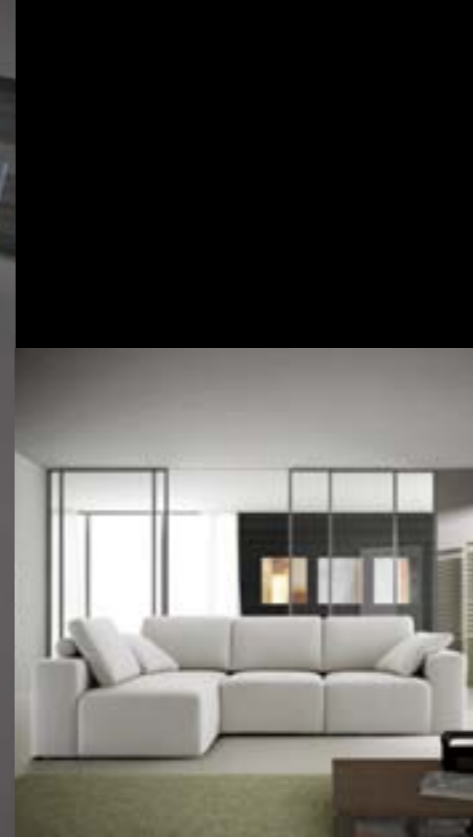

credits

Style

Centro stile Samoa, Treviso

Concept, Graphic design

Neiko, Treviso

Images

Neiko, Treviso

Print

GFP, Pordenone

SAMOA

DIVANI E IMBOTTITI

SAMOA SRL
31014 Colle Umberto (TV) - ITALY
Via I° Maggio, 9/11 (Z.I.)
Tel. 0438 388179
Fax 0438 430482
www.samoativani.com
info@samoativani.com



R e f l e c t
& S h i n e

Reflect

Reflect 04
Tecnicamente 44



Shine

Shine 22
Tecnicamente 46





Reflect

Reflect



Divano cm 195
con sedute estraibili.
Due cuscini poggiatesta cm 65x27.

195 cm Sofa
with Pull-out Seats.
Two 65x27 cm Lumbar Cushions.

Concetto di **spazio intelligente**.
Reflect è il divano ideale, in
cui poggiatesta reclinabili e
sedute estraibili indipendenti
entusiasmano in ogni posizione,
garantendo **molteplici possibilità
di comfort**.

The concept of smart space.
Reflect is the perfect sofa,
where reclining headrests and
freestanding pull-out seats ensure
maximum comfort in any position.





Divano laterale
cm 176 sx e penisola angolare
con pouff cm 238 dx.
Piedini Steel.
Un cuscino decoro cm 40x40.

176 cm Left-hand Sofa
and 238 cm Right-hand Corner
Peninsula with Pouf.
Steel Feet.
One 40x40 cm
Decorative Cushions.

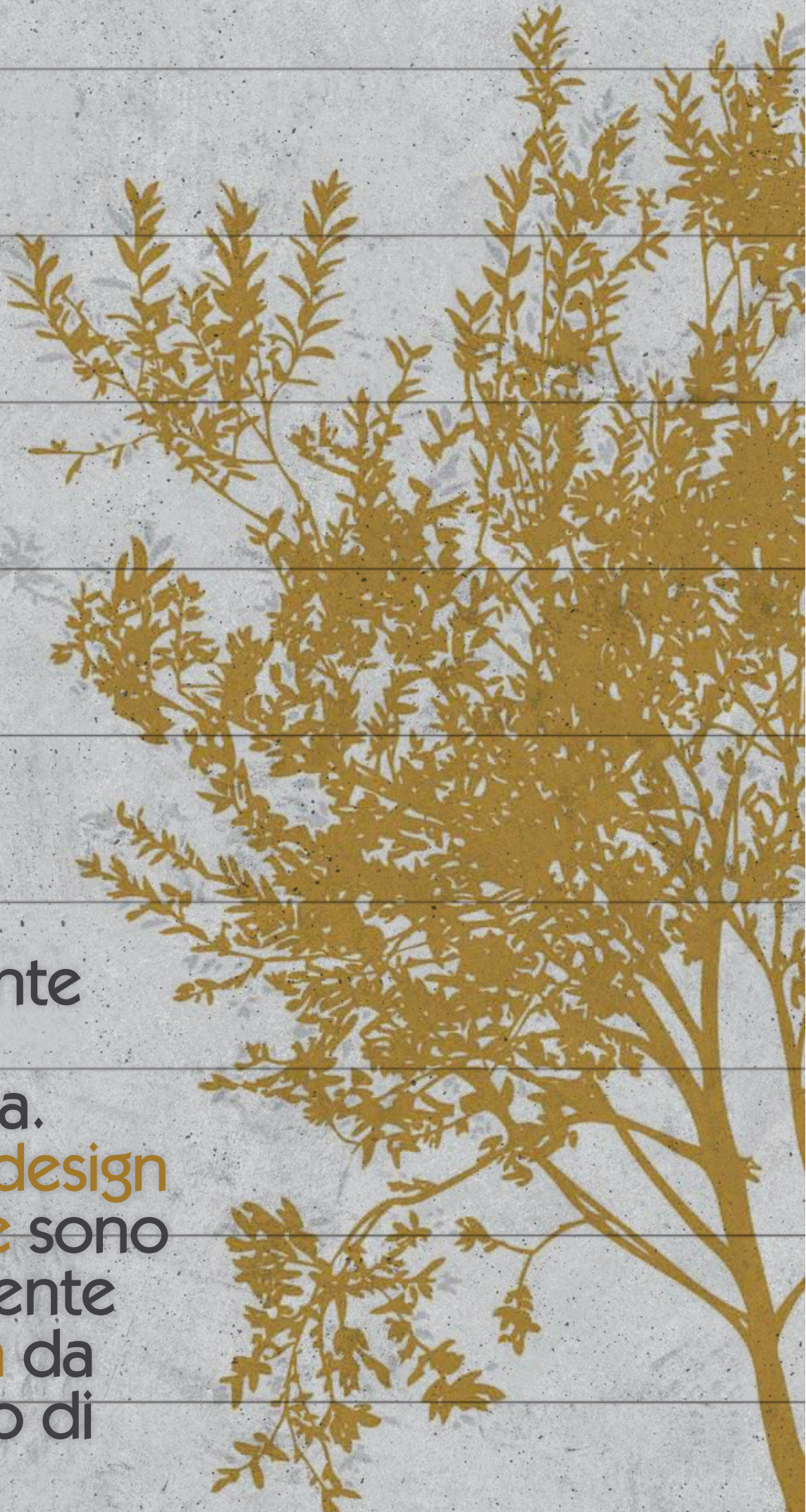

Emozionante
da ogni
prospettiva.
In Reflect **design**
e funzione sono
perfettamente
in armonia da
ogni punto di
vista.

All-round Emotion.
Design and functionality harmoniously
embrace Reflect from all angles.



Infinite Possibilità.

Le svariate possibilità di movimento dei cuscini poggiatesta permettono molteplici posizioni garantendo una comodità del tutto personale.

Infinite Possibilities.
Headrest cushions can be moved however you like: multiple positions for total personal comfort.



Reflect



**Divano laterale cm 176
sx con sedute estraibili e
penisola angolare cm 205 dx.
Due cuscini poggiatesta cm 65x27
e un cuscino decoro cm 40x40.**

176 cm Left-hand Sofa
with Pull-out Seats and 205 cm
Right-hand Corner Peninsula.
Two 65x27 cm Lumbar Cushions
and one 40x40 cm Decorative
Cushion.



Divano laterale cm 156
dx con sedute estraibili,
angolo curvo e divano laterale
cm 156 sx.
Piedini Brick in legno colore beige.
Due cuscini poggiatesta cm 55x27.

156 cm Right-hand Sofa
with Pull-out Seats, Curved Corner
and 156 cm Left-hand Sofa.
Beige Wooden Brick Feet.
Two 55x27 cm
Lumbar Cushions.

Esaltazione della funzionalità.
Componibilità e funzioni
ingegnose sono ingredienti
ideali per soddisfare molteplici
esigenze d'arredo, regalando
l'eccellenza nel comfort.

Highlights of Functionality.
Various arrangement solutions
and smart functions ideally satisfy
multiple furnishing needs with
maximum excellence in comfort.



Shine



Shine



Divano cm 215.
Piedini Zed finitura manganese.
215 cm Sofa.
Manganese Colour Zed Feet.



Divano laterale cm 176 sx
e angolo penisola
con pouff cm 220 dx.
Piedini Zed finitura cromo.
Quattro cuscini decoro cm 40x40.

176 cm Left-hand Sofa and 220 cm
Right-hand Corner Peninsula with Pouf.
Chrome Colour Zed Feet.
Four 40x40 cm
Decorative Cushions.



Nulla viene lasciato al caso.
Accessori di design e tessuti
pregiati contribuiscono ad
esaltare le forme sinuose e
raffinate di Shine.

Nothing is left to chance.
Design accessories and
precious fabrics contribute to
emphasizing Shine's curvy,
refined shapes.



Shine



Divano cm 215.
215 cm Sofa.



Divano laterale
cm 176 sx con sedute
estraibili e panchetta dx.
Piedini Model
finitura manganese.
Due cuscini poggiatesta cm 65x27
e due cuscini decoro cm 40x40.

176 cm Left-hand Sofa with Pull-out
Seats and Bench to the Right.
Manganese Colour Model Feet.
Two 65x27 cm Lumbar Cushions
and two 40x40 cm
Decorative Cushions.

Nuovi standard in termini di **comfort e dinamismo**.
Shine è il divano che esprime design e funzionalità, per un pubblico esigente che desidera **scegliere senza compromessi**.

New comfort and dynamism standards.
For a demanding target audience who would like to make their choice with no compromises: Shine is the sofa with design and functionality.





**Versatile e confortevole.
Interpretazione originale
dove linee tradizionali
vengono rivisitate
in chiave moderna
per un relax ideale.**

Versatile and comfortable.
Originally reinterpreting
perfect relax through
traditional lines
with a modern twist.



Divano laterale
cm 176 sx e
angolo goccia dx.
Piedini Model finitura cromo.
Due cuscini decoro cm 40x40
e un cuscino decoro cm 55x45.

176 cm Left-hand Sofa and
Right-hand Teardrop Corner.
Chrome Colour Model Feet.
Two 40x40 cm Decorative
Cushions and one 55x45 cm
Decorative Cushion.

Spazio speciale.
Per arredare con classe
ogni ambiente,
la collezione propone
elementi e accessori originali.

Special space.
Original items and accessories that
decorate any setting with style.

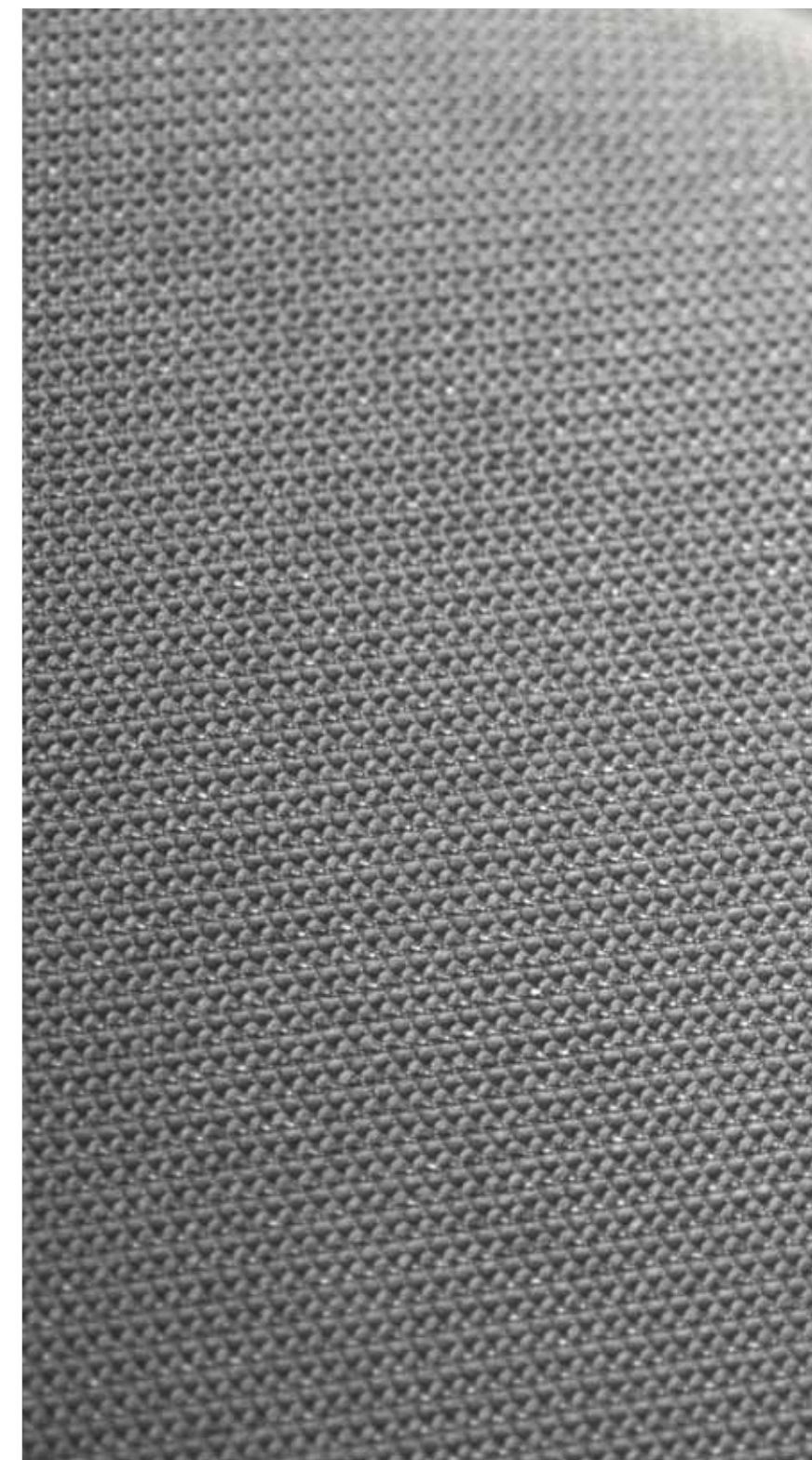



TECNICAMENTE

REFLECT divani/elementi

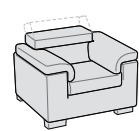

Poltrona
L 108 P 105 H 76/97
1 seduta estraibile

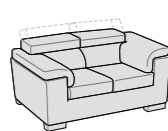

Divano
L 155 P 105 H 76/97
2 sedute estraibili

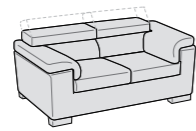

Divano
L 175 P 105 H 76/97
2 sedute estraibili

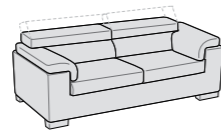

Divano
L 195 P 105 H 76/97
2 sedute estraibili

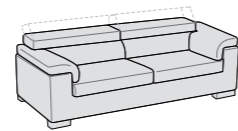

Divano
L 215 P 105 H 76/97
2 sedute estraibili

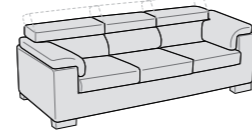

Divano
L 245 P 105 H 76/97
3 sedute estraibili

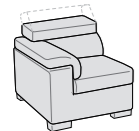

Poltrona laterale dx/sx
L 89 P 105 H 76/97
1 seduta estraibile

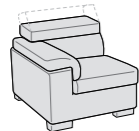

Poltrona maxi laterale dx/sx
L 99 P 105 H 76/97
1 seduta estraibile

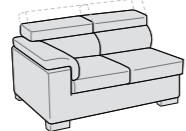

Divano laterale dx/sx
L 136 P 105 H 76/97
2 sedute estraibili

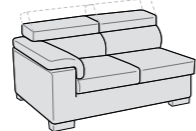

Divano laterale dx/sx
L 156 P 105 H 76/97
2 sedute estraibili

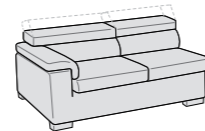

Divano laterale dx/sx
L 176 P 105 H 76/97
2 sedute estraibili

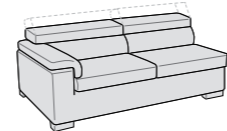

Divano laterale dx/sx
L 196 P 105 H 76/97
2 sedute estraibili

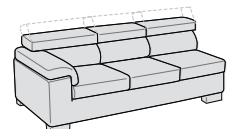

Divano laterale dx/sx
L 226 P 105 H 76/97
3 sedute estraibili

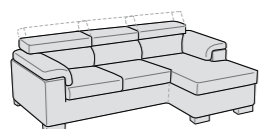

Componibile panchetta reversibile
L 230 P 160 H 76/97

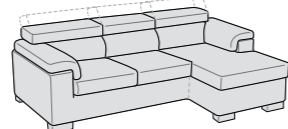

Componibile panchetta reversibile
L 245 P 160 H 76/97

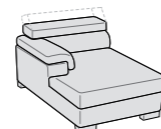

Panchetta dx/sx
L 98 P 160 H 76/97

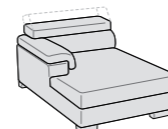

Panchetta maxi dx/sx
L 108 P 160 H 76/97

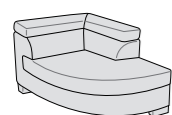

Angolo goccia dx/sx
L 130 P 183 H 76

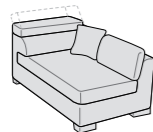

Penisola angolare dx/sx
L 102 P 185 H 76/97

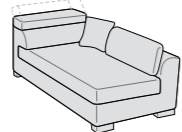

Penisola angolare dx/sx
L 102 P 205 H 76/97

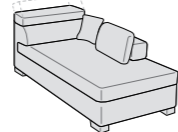

Penisola angolare
c/pouff dx/sx
L 102 P 218 H 76/97

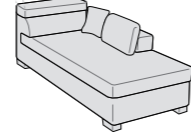

Penisola angolare
c/pouff dx/sx
L 102 P 238 H 76/97

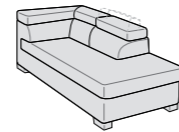

Angolo penisola
c/pouff dx/sx
L 105 P 220 H 76/97
(1 poggiatesta reclinabile)

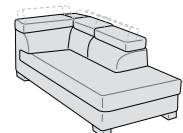

Angolo penisola c/pouff
dynamic dx/sx
L 105 P 220 H 76/97
(3 poggiatesta reclinabili)

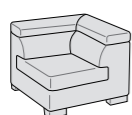

Angolo retto
L 105 P 105 H 76

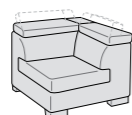

Angolo retto dynamic
L 105 P 105 H 76/97
(2 poggiatesta reclinabili)

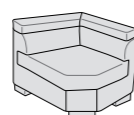

Angolo aperto
L 130 P 130 H 76

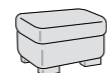

Pouff
L 85 P 65 H 44

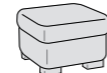

Pouff
L 95 P 95 H 44

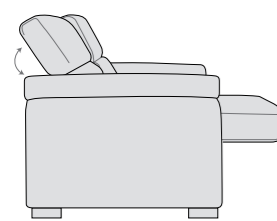

Con seduta estraibile aperta P cm 140.
140 cm deep with pull-out seat opened.

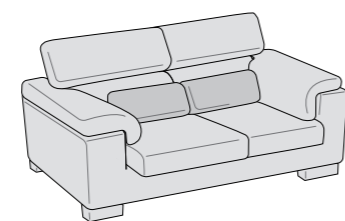

Per migliorare ulteriormente il comfort, negli elementi con sedute estraibili si consiglia l'utilizzo del cuscino poggiatesta.

We suggest using the lumbar cushion in sofas and armchairs with pull-out seats for maximum comfort.

REFLECT divani letto/accessori

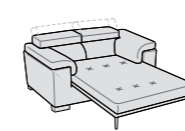

Divano letto
L 155 P 235 H 76/97

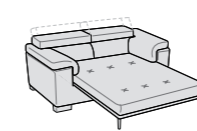

Divano letto
L 175 P 235 H 76/97

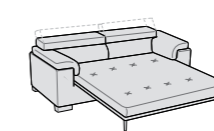

Divano letto
L 195 P 235 H 76/97

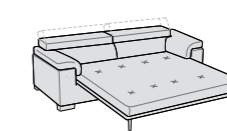

Divano letto
L 215 P 235 H 76/97

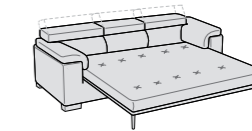

Divano letto
L 245 P 235 H 76/97

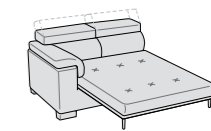

Divano laterale dx/sx letto
L 136 P 235 H 76/97

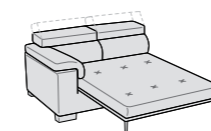

Divano laterale dx/sx letto
L 156 P 235 H 76/97

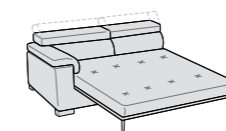

Divano laterale dx/sx letto
L 176 P 235 H 76/97

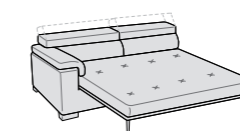

Divano laterale dx/sx letto
L 196 P 235 H 76/97

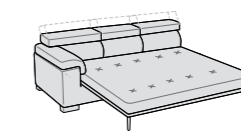

Divano laterale dx/sx letto
L 226 P 235 H 76/97

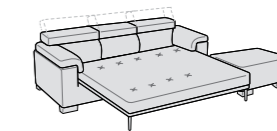

Componibile panchetta reversibile letto
L 230 P 235 H 76/97

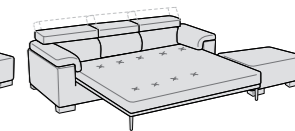

Componibile panchetta reversibile letto
L 245 P 235 H 76/97



Cuscino decoro
L 40 x 40



Cuscino decoro
L 55 x 45



Cuscino bracciolo
L 50 x 50

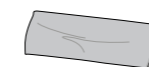

Cuscino poggiatesta
L 75 x 27
(divano cm 215,
divano lat. cm 196,
panchetta maxi)

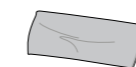

Cuscino poggiatesta
L 65 x 27
(divano cm 195,
divano lat. cm 176,
poltrona maxi lat.,
panchetta,
penisola ang.,
penisola ang. c/pouff)



Cuscino poggiatesta
L 55 x 27
(divano cm 175,
divano lat. cm 156,
divano lat. cm 226,
poltrona,
poltrona lat.,
componibile panchetta
reversibile cm 245,
angolo penisola c/pouff)



Cuscino poggiatesta
L 45 x 27
(divano cm 155,
divano lat. cm 136,
componibile panchetta
reversibile cm 230)

REFLECT tipologie piedini



Piedino Brick in legno colore nero **di serie.**
Standard black wooden
Brick foot.



Piedino Brick in legno colore beige **optional.**
Optional beige wooden
Brick foot.



Piedino Steel in metallo **optional.**
Optional metal Steel foot.

SHINE divani/elementi

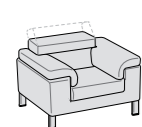

Poltrona
L 108 P 105 H 76/97
1 seduta estraibile

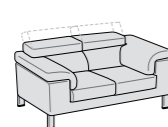

Divano
L 155 P 105 H 76/97
2 sedute estraibili

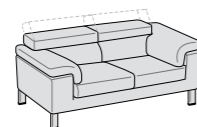

Divano
L 175 P 105 H 76/97
2 sedute estraibili

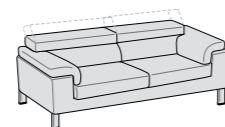

Divano
L 195 P 105 H 76/97
2 sedute estraibili

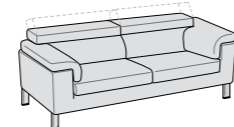

Divano
L 215 P 105 H 76/97
2 sedute estraibili

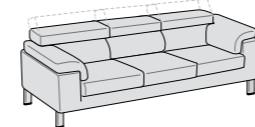

Divano
L 245 P 105 H 76/97
3 sedute estraibili

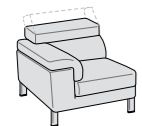

Poltrona laterale dx/sx
L 89 P 105 H 76/97
1 seduta estraibile

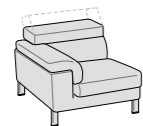

Poltrona maxi laterale dx/sx
L 99 P 105 H 76/97
1 seduta estraibile

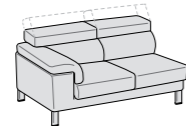

Divano laterale dx/sx
L 136 P 105 H 76/97
2 sedute estraibili

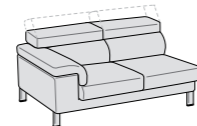

Divano laterale dx/sx
L 156 P 105 H 76/97
2 sedute estraibili

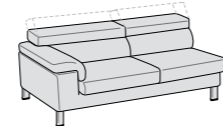

Divano laterale dx/sx
L 176 P 105 H 76/97
2 sedute estraibili

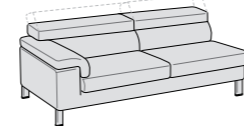

Divano laterale dx/sx
L 196 P 105 H 76/97
2 sedute estraibili

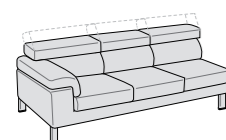

Divano laterale dx/sx
L 226 P 105 H 76/97
3 sedute estraibili

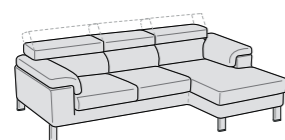

Componibile panchetta reversibile
L 230 P 160 H 76/97

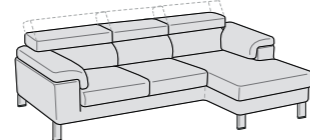

Componibile panchetta reversibile
L 245 P 160 H 76/97

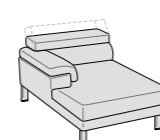

Panchetta dx/sx
L 98 P 160 H 76/97

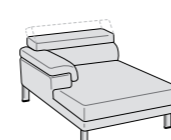

Panchetta maxi dx/sx
L 108 P 160 H 76/97

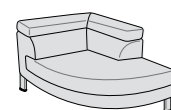

Angolo goccia dx/sx
L 130 P 183 H 76

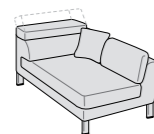

Penisola angolare dx/sx
L 102 P 185 H 76/97

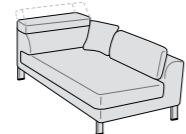

Penisola angolare dx/sx
L 102 P 205 H 76/97

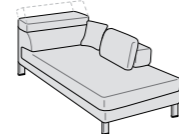

Penisola angolare
c/pouff dx/sx
L 102 P 218 H 76/97

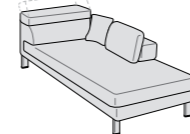

Penisola angolare
c/pouff dx/sx
L 102 P 238 H 76/97

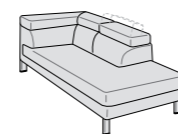

Angolo penisola
c/pouff dx/sx
L 105 P 220 H 76/97
(1 poggiatesta reclinabile)

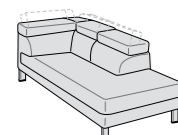

Angolo penisola c/pouff
dynamic dx/sx
L 105 P 220 H 76/97
(3 poggiatesta reclinabili)



Angolo retto
L 105 P 105 H 76

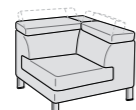

Angolo retto dynamic
L 105 P 105 H 76/97
(2 poggiatesta reclinabili)

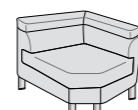

Angolo aperto
L 130 P 130 H 76



Pouff
L 85 P 65 H 44



Pouff
L 95 P 95 H 44

SHINE accessori



Cuscino decoro
L 40 x 40



Cuscino decoro
L 55 x 45



Cuscino bracciolo
L 50 x 50

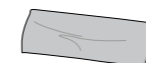

Cuscino poggiareni
L 75 x 27
(divano cm 215,
divano lat. cm 196,
panchetta maxi)



Cuscino poggiareni
L 65 x 27
(divano cm 195,
divano lat. cm 176,
poltrona maxi lat.,
panchetta,
penisola ang.,
penisola ang. c/pouff)



Cuscino poggiareni
L 55 x 27
(divano cm 175,
divano cm 245,
divano lat. cm 156,
divano lat. cm 226,
poltrona,
poltrona lat.,
componibile panchetta
reversibile cm 245,
angolo penisola c/pouff)



Cuscino poggiareni
L 45 x 27
(divano cm 155,
divano lat. cm 136,
componibile panchetta
reversibile cm 230)

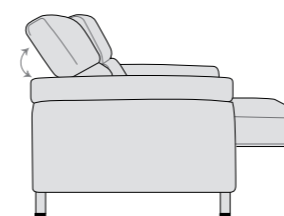

Con seduta estraibile aperta P cm 140.
140 cm deep with pull-out seat opened.

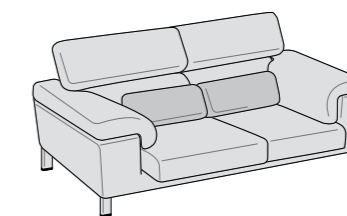

Per migliorare ulteriormente il comfort, negli elementi con sedute estraibili si consiglia l'utilizzo del cuscino poggiareni.

We suggest using the lumbar cushion in sofas and armchairs with pull-out seats for maximum comfort.

SHINE tipologie piedini



Piedino Easy finitura cromo di serie.
Standard chrome Easy foot.



Piedino Model finitura cromo optional.
Optional chrome Model foot.



Piedino Model finitura manganese optional.
Optional manganese Model foot.



Piedino Zed finitura cromo optional.
Optional chrome Zed foot.



Piedino Zed finitura manganese optional.
Optional manganese Zed foot.

REFLECT esploso

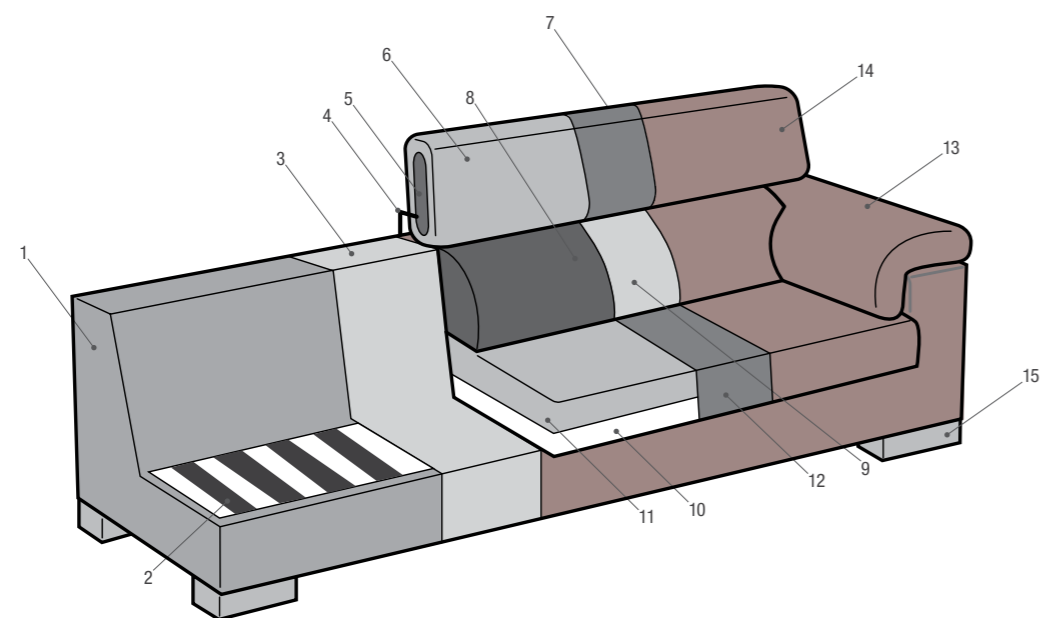

SHINE esploso

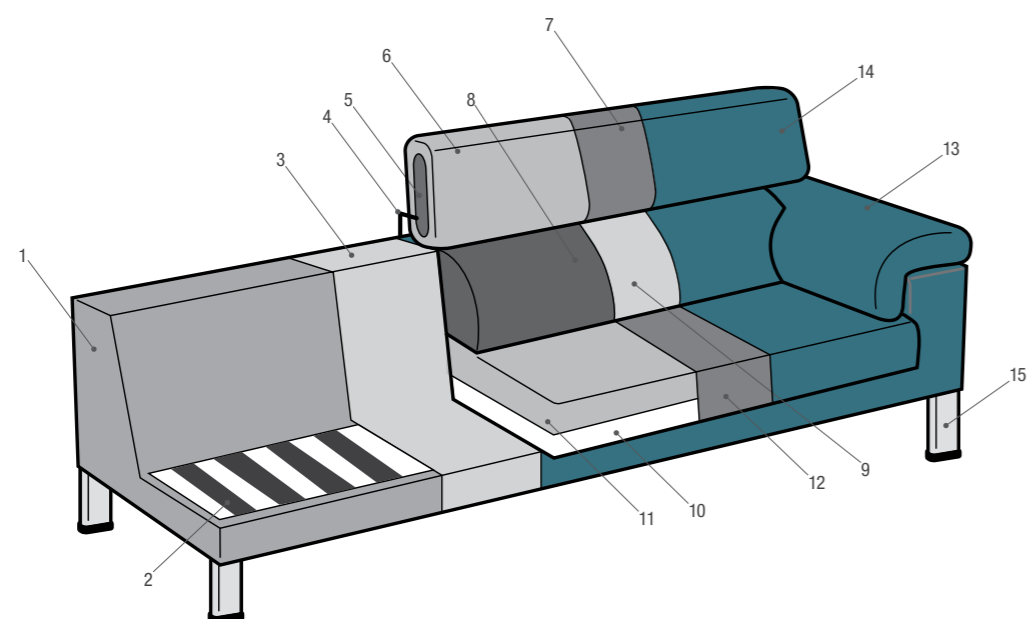

Legenda

1. Struttura in legno stagionato e agglomerato.
Frame in seasoned wood and agglomerated wood.
2. Molleggio seduta nastri elastici in fibra propilenica e lattice da 80 mm tesi meccanicamente.
Seat sprung in mechanically-tensioned 80-mm propylene fibre and latex webbing.
3. Rivestimento in vellutino accoppiato a fibra di poliestere gr 300.
Covered in coupled velveteen and 300 gr polyester fibre.
4. Meccanismo cromato per movimento schienale/poggiatesta.
Chromed back/headrest mechanism.
5. Inserto in legno stagionato.
Seasoned wood insert.
6. Cuscino poggiatesta in poliuretano espanso indeformabile D 18.
Headrest cushion in non-deforming D 18 polyurethane foam.
7. Rivestimento in ovatta di poliestere.
Covered in polyester wadding.
8. Cuscino lombare in poliuretano espanso indeformabile D 21.
Lumbar cushion in non-deforming D 21 polyurethane foam.
9. Rivestimento in vellutino accoppiato a fibra di poliestere gr 300.
Covered in 300 gr coupled velveteen and polyester fibre.
10. Cuscino seduta in poliuretano espanso indeformabile D 32.
Seat cushion in non-deforming D 32 polyurethane foam.
11. Bombatura seduta in poliuretano espanso indeformabile D 28.
Seat upholstery in non-deforming D 28 polyurethane foam.
12. Rivestimento in ovatta di poliestere.
Covered in polyester wadding.
13. Cuscino bracciolo in poliuretano espanso indeformabile D 21/30.
Armrest cushion in non-deforming D 21/30 polyurethane foam.
14. Rivestimento in tessuto, pelle o ecopelle.
Covered in fabric, leather or eco leather.
15. Piedini Brick o Steel modello Reflect - Piedini Easy, Model o Zed modello Shine.
Brick or Steel feet for Reflect models - Easy, Model or Zed feet for Shine models.

REFLECT & SHINE nel dettaglio



Particolare del meccanismo poggiatesta con rivestimenti in pelle od ecopelle, parzialmente sfoderabili.

Component of the sofa headrest mechanism upholstered in partially removable leather or eco-leather.



Particolare del meccanismo poggiatesta con rivestimenti in tessuto, completamente sfoderabile.

Component of the sofa headrest mechanism upholstered in completely removable fabric



Le sedute, estraibili manualmente, sono indipendenti dalle posizioni del cuscino poggiatesta. Per migliorare ulteriormente il comfort, negli elementi con sedute estraibili si consiglia l'utilizzo del cuscino poggiatesta.

Pull-out seats can be managed manually and independently from headrest cushion. We suggest using the lumbar cushion in sofas and armchairs with pull-out seats for maximum comfort.



I cuscini poggiatesta si possono regolare in molteplici posizioni.

Headrest cushions can be adjusted in different positions.



Design
e funzione



Relax
vero



Versatile
e confortevole



Forme
raffinate



SAMOA SRL

31014 Colle Umberto (TV) - ITALY
Via I° Maggio, 9/11 (Z.I.)

Tel. +39 0438 388179

Fax +39 0438 430482

www.samoadivani.com

www.bsideletti.it

info@samoadivani.com



SAMOA produce con energia pulita.
SAMOA produces with clean energy.

CREDITS:

Style

Centro stile Samoa, Treviso

Concept, Graphic design

Neiko, Treviso

Images

Neiko, Treviso

Print

GFP, it