

PINTDECOR®

WALLPANEL

MADE IN ITALY



**Pannelli innovativi per rivestimento pareti
Innovative panels for wall covering
Panneaux innovants pour le revêtement mural**

indice index

<i>Perchè scegliere PINTDECOR WALL PANEL?</i> <i>Why choose PINTDECOR WALL PANEL?</i> <i>Pourquoi choisir PINTDECOR WALL PANEL?</i>	4 - 5
<i>WALL PANEL CLASSIC</i> <i>WALL PANEL CLASSIC tinta unita - plain colored - couleur unie</i>	6 - 115 116 - 117
<i>Optional LAVAGNA</i> <i>BLACKBOARD Optional</i> <i>TABLEAU NOIR Optionel</i>	118
<i>Optional LUCIDO</i> <i>GLOSSY FINISH Optional</i> <i>FINITION BRILLANTE Optionnelle</i>	119
<i>WALL PANEL MAGNETIC - ACCESSORI MAGNETICI</i> <i>MAGNETIC WALL PANEL - MAGNETIC ACCESSORIES</i> <i>WALL PANEL MAGNETIC - ACCESSOIRES MAGNÉTIQUES</i>	120 - 123
<i>WALL PANEL 3D</i> <i>WALL PANEL SPECIAL</i> <i>WALL PANEL ARTISTIC</i> <i>WALL PANEL BASIC</i>	124 - 143 144 - 147 148 - 157 158 - 159
<i>NON SOLO CUCINE</i> <i>NOT ONLY KITCHENS</i> <i>PAS SEULEMENT DES CUISINES</i>	160 - 163
<i>Personalizzazioni</i> <i>Customized</i> <i>Personnalisations</i>	164 - 165
<i>EXTRA - Campionari e Profilo in acciaio</i> <i>EXTRA - Samples and steel profile</i> <i>EXTRA - Échantillons et Profil en acier</i>	166 - 167
<i>GLASS PANEL - PARASCHIZZI</i> <i>GLASS PANEL - SPLASHBACK</i> <i>GLASS PANEL - CRÉDENCES VERRE</i>	168 - 181
<i>Istruzioni di montaggio</i> <i>Assembly instruction</i> <i>Notice de montage</i>	182 - 183
<i>Certificazione Certification</i> <i>Avvertenze - Warnings - Avertissements</i> <i>Indice con codici - Index with codes - Index avec codes</i> <i>Listino prezzi - Price list - Liste de prix</i>	184 185 186 - 187 189

Perchè scegliere PINTDECOR WALL PANEL?

Why choose PINTDECOR WALL PANEL?

Pourquoi choisir PINTDECOR WALL PANEL?

prima before avant



dopo after après



I nostri pintdecor wall panel rappresentano una soluzione moderna ed elegante per decorare e proteggere la tua parete in alternativa ai comuni rivestimenti di piastrelle. La superficie omogenea del pannello si distingue principalmente per la totale assenza di fughe che permette una pulizia veloce e profonda. Sono perfetti sia per ambienti nuovi che per ristrutturazioni, con il vantaggio di non richiedere personale specializzato e manodopera ad alto costo per essere installati.

Our pintdecor wall panels represent a modern and elegant solution to decorate and protect your wall as an alternative to common tile covering. The uniform panel surface is distinguished mainly by the total absence of groutings which allows for fast and thorough cleaning. They are perfect for both new environments and renovations, but they don't need a highly qualified staff and high-cost labor to be installed.

Nos crédences pintdecor représentent une solution moderne et élégante pour décorer et protéger votre mur au lieu d'un revêtement de carrelage habituel. La surface homogène du panneau se distingue principalement par l'absence totale de joints qui permet un nettoyage rapide et en profondeur. Elles sont parfaites pour les nouveaux environnements et les rénovations, mais ont l'avantage de ne pas nécessiter de personnel hautement qualifié et d'une main-d'œuvre coûteuse pour être installées.

- Pannello di alta qualità formato da due fogli di alluminio accoppiati su un'anima in polietilene estruso, completamente privo di metalli pesanti e conforme alle normative europee.
- Certificato CATAS per la resistenza al calore, ai liquidi e ai graffi.
- Spessore complessivo mm.3, dimensione massima cm. 300 x 150 (singolo pannello), peso 4 kg/m².
- Dopo la stampa in alta definizione, al pannello viene applicato un trattamento protettivo con finitura opaca per garantire colori intensi che durano nel tempo.
- Possono essere posizionati dietro piani cottura elettrici, in vetroceramica e a induzione.

-NON SONO ADATTI PER ESSERE POSIZIONATI DIETRO I PIANI COTTURA CON BRUCIATORE A TRIPLA CORONA POSTERIORE.
-NELLE CUCINE DOVE È PRESENTE L'ALZATINA ATTACCATA AL MURO, IL WALL PANEL DEVE ESSERE MONTATO SOPRA L'ALZATINA.
-NON METTERE PENTOLE ROVENTI A CONTATTO DIRETTO CON IL PANNELLO.

- High quality panel composed by two aluminum sheets coupled on an extruded polyethylene core, completely free from heavy metals and compliant with European regulations.
- CATAS certified for resistance to heat, liquids and scratches.
- Total thickness 3 mm, maximum size cm. 300 x 150 (single panel), Weight 4 kg / m².
- After the high definition printing, a protective treatment with a matte finish is applied to the panel in order to guarantee some intense colors that last over time.
- Panels can be placed behind electric, glass ceramic and induction cooktops.

-THEY ARE NOT SUITABLE TO BE PLACED BEHIND THE COOKTOPS WITH A REAR TRIPLE CROWN BURNER.
-IN KITCHENS WITH THE SPLASHBACK IS GLUED TO THE WALL, THE WALL PANEL SHOULD BE MOUNTED ABOVE THE SPLASHBACK.
-DO NOT PUT RED-HOT PANS IN CLOSE CONTACT WITH THE PANEL.

- Panneau de haute qualité composé par deux feuilles d'aluminium couplées sur une âme en polyéthylène extrudé, sans métaux lourds et conforme à la réglementation européenne.
- Certifié CATAS pour sa résistance à la chaleur, aux liquides et rayures.
- Épaisseur totale 3 mm, taille maximale cm. 300 x 150 (panneau unique), Poids 4 kg / m².
- Après l'impression en haute définition, un traitement de protection avec une finition mate est appliqué sur le panneau pour garantir des couleurs intenses qui durent dans le temps.
- Les crédences peuvent être placées derrière des plaques électriques, vitrocéramiques et à induction.
- Prévoir un plan de travail de profondeur 65cm pour une plaque gaz.

-ELLES NE SONT PAS CONVENABLES À ÊTRE PLACÉES DERRIÈRE DES PLAQUES À GAZ AVEC COURONNE TRIPLE ARRIÈRE.
-DANS LES CUISINES OÙ IL YA UN DOSSERET FIXÉE AU MUR, LE WALL PANEL DOIT ÊTRE MONTÉ AU-DESSUS DU DOSSERET.
-NE PAS METTRE LES POÊLES CHAUDES EN CONTACT DIRECT AVEC LES CRÉDENCES.

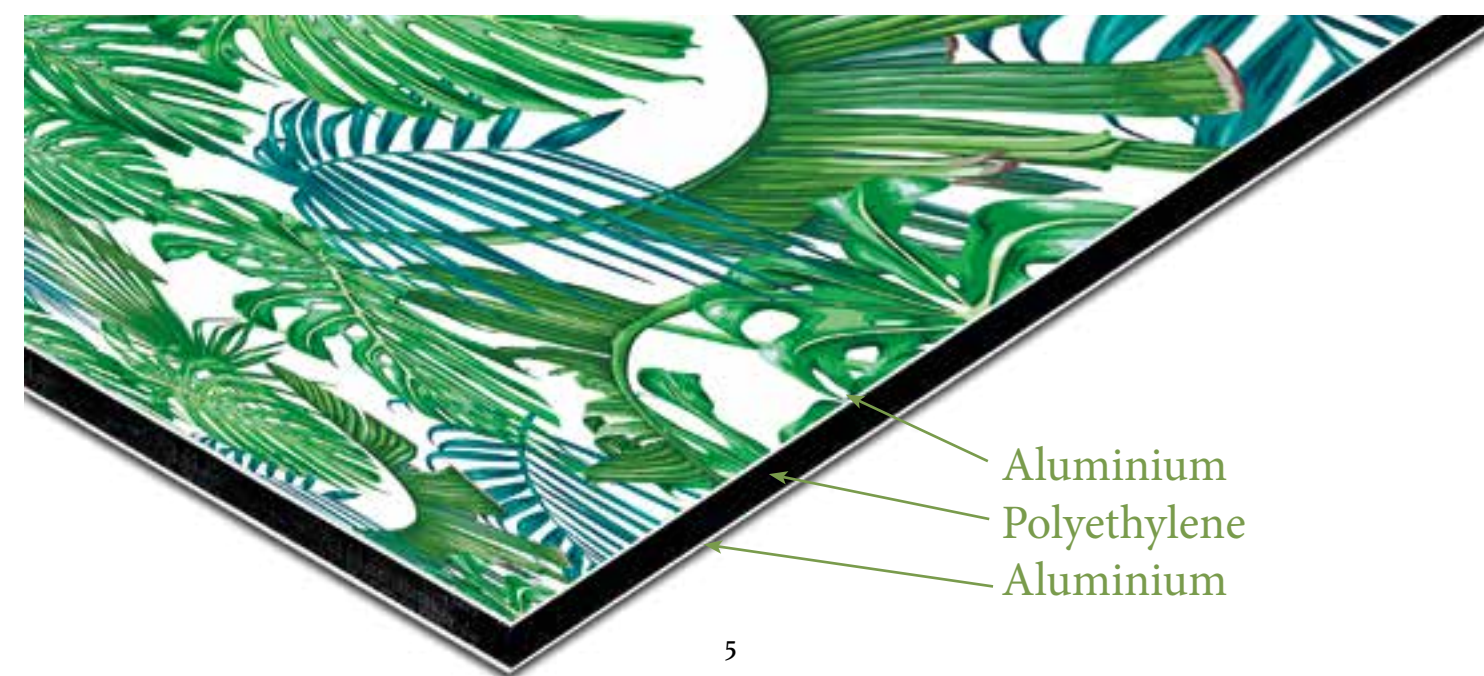





















WP1952



WP1816



WP1020



WP1040



WALLPANEL CLASSIC
WP1802

*Un contrasto deciso tra
il bianco ottico della cucina
e il verde intenso delle foglie.*

*A strong contrast between
the optical white of the kitchen
and the intense green of the leaves.*

*Un fort contraste entre
le blanc optique de la cuisine
et le vert intense des feuilles.*



WP1806



WP1066



WP1802



WP1800



WP1812



WP1814



WP1980



WP1804



WP1918





WP1032



WP1998



WP1956



WP1072



WP1878



WP1030



WP1960



WP2006



WP1036



WP1062



WP1884



WP1830



WP1842



WP1876



WP1044



WP1920



WP1016



WP1972



WP1056



WP1050





WP1116



WP1874



WP2014

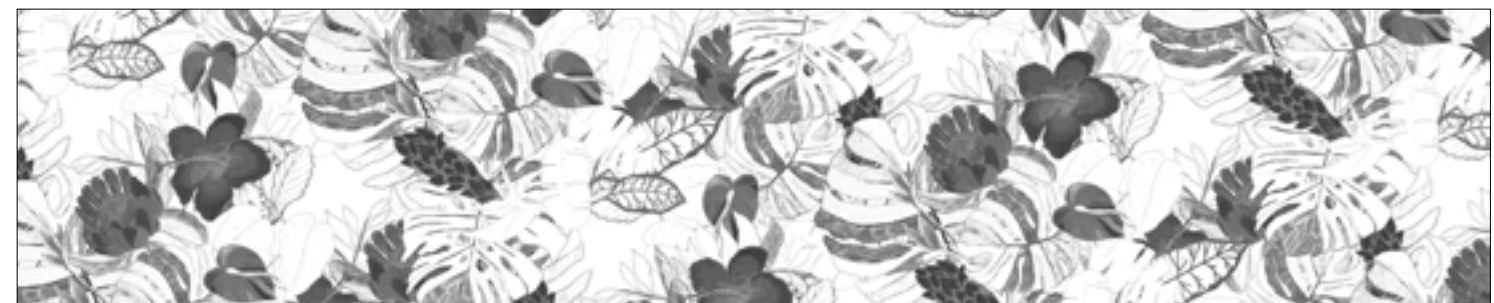

WP1880



WP2010



WP2012



WP1882



WP1846

WALLPANEL CLASSIC WP1332



WALLPANEL CLASSIC WP1324





WP1338



WP2036



WP1332



WP1328



WP1324



WP1922



WP1322



WP1910

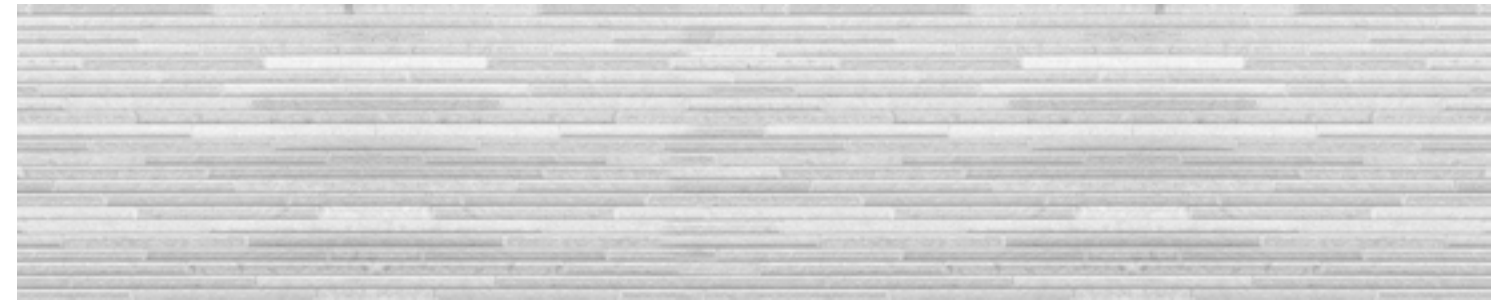

WP1326

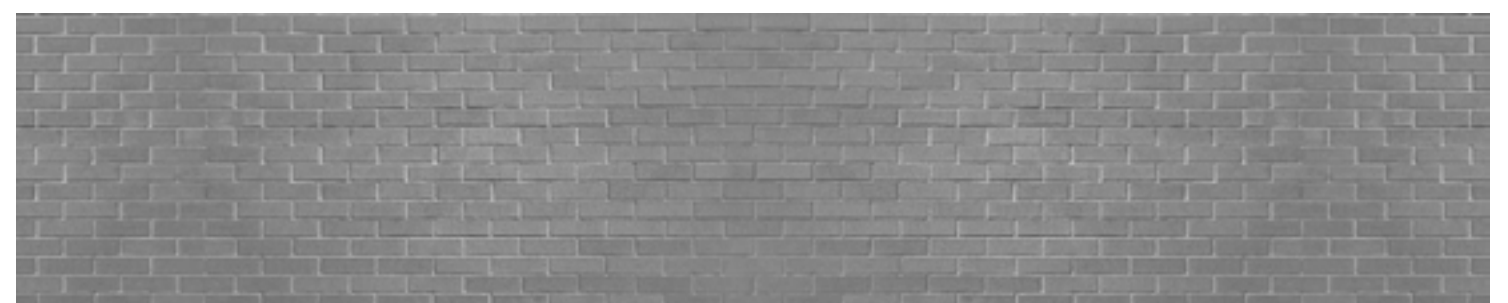

WP1342





WALLPANEL CLASSIC
WP2028

*Le venature giallo-oro
rendono il marmo bianco
caldo e avvolgente.*

*The yellow-gold veins make
the white marble warm
and enveloping.*

*Les veines en or jaune rendent
le marbre blanc chaleureux
et enveloppant.*

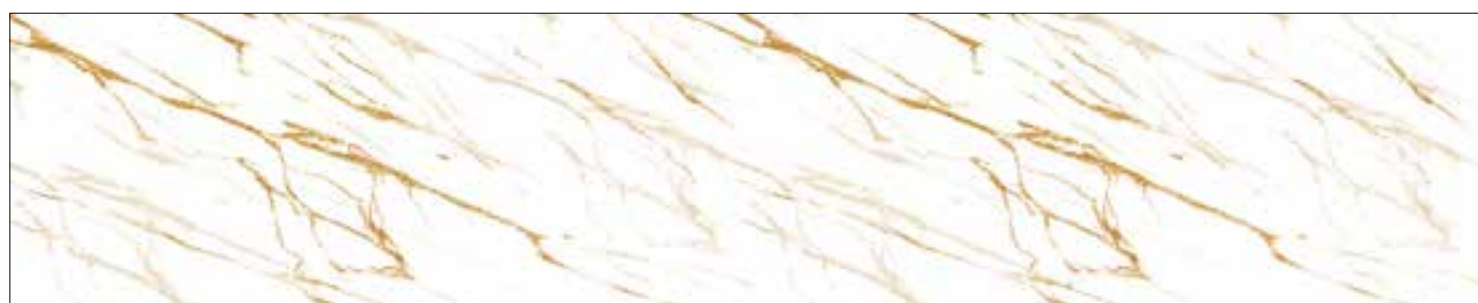

WP2028



WP1808



WP1854



WP1852

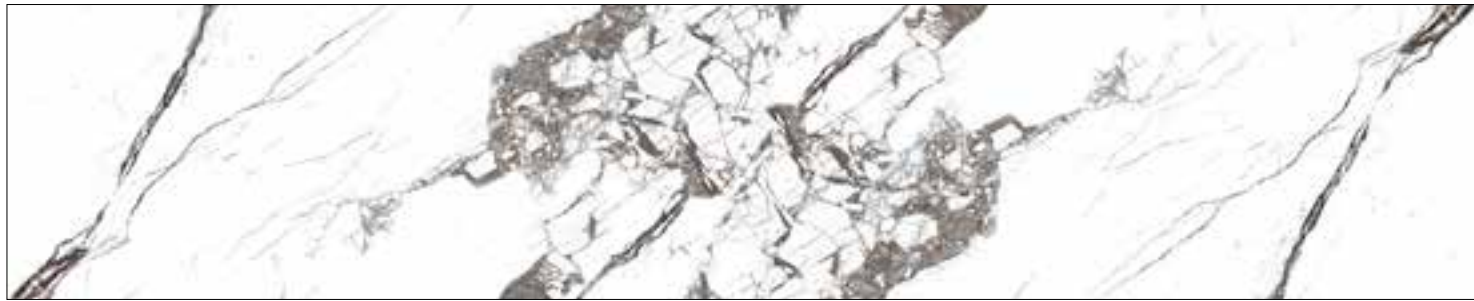

WP1850



WP2032



WP2030



WP1810



WP2018



WP2020



WP1222



WP1228

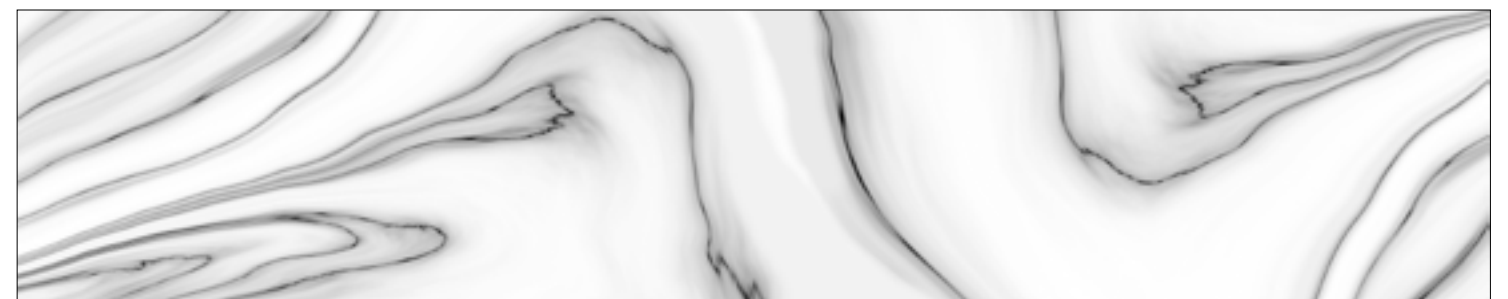

WP1230



WP1234







WP1856



WP1916



WP1860



WP1838



WP1858

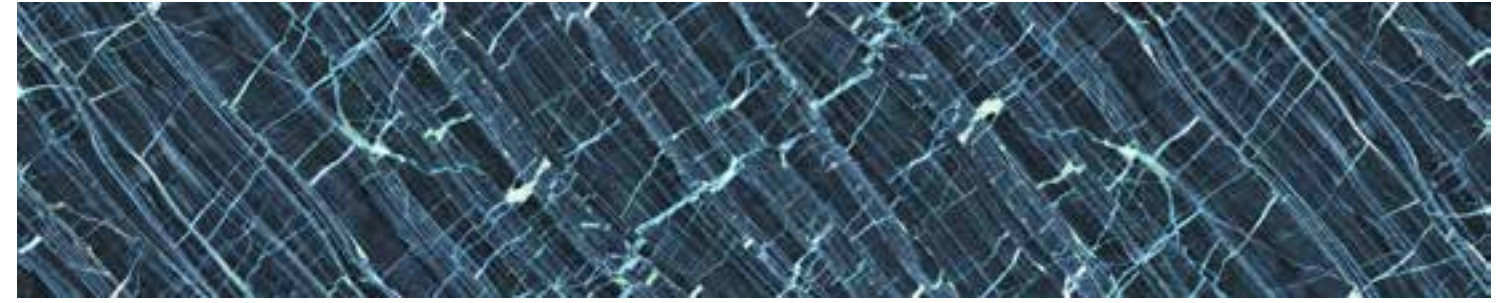

WP1862



WP1210

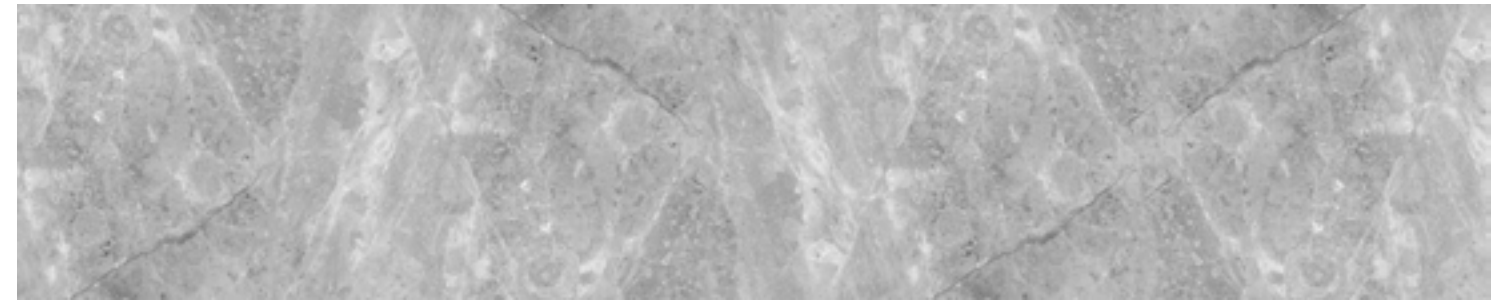

WP1836



WP1214



WP1252

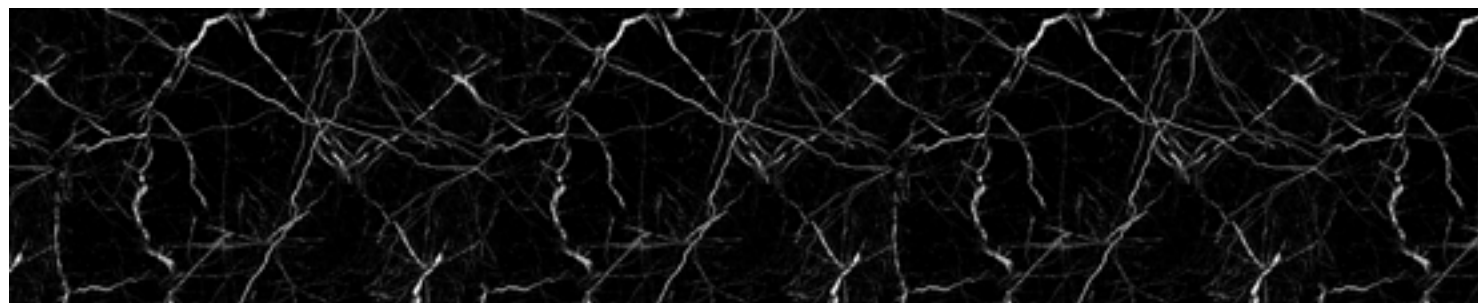

WP1242



WP1248



WP1864



WP1246





WP1892



WP1286



WP1890



WP1284



WP1888



WP1288



WP1278



WP1900



WP1844



WP1904

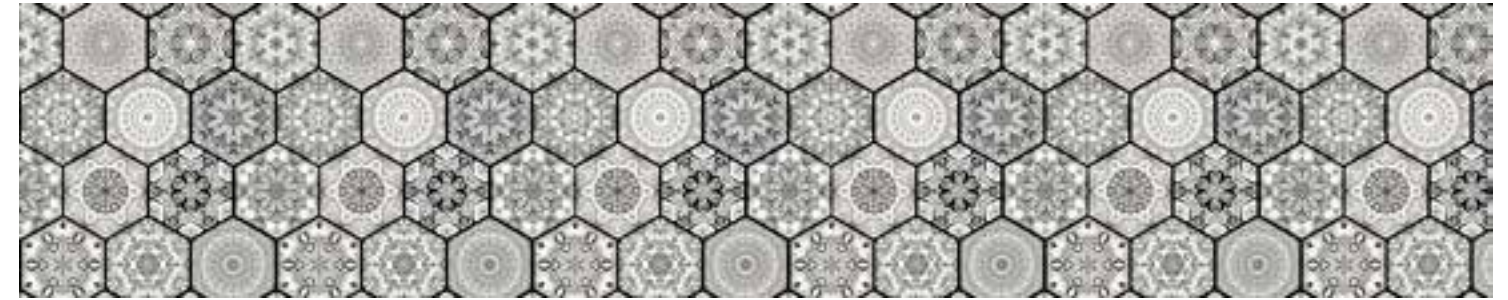

WP1280



WP1282



WP1894



WP1258



WP1886



WP1902

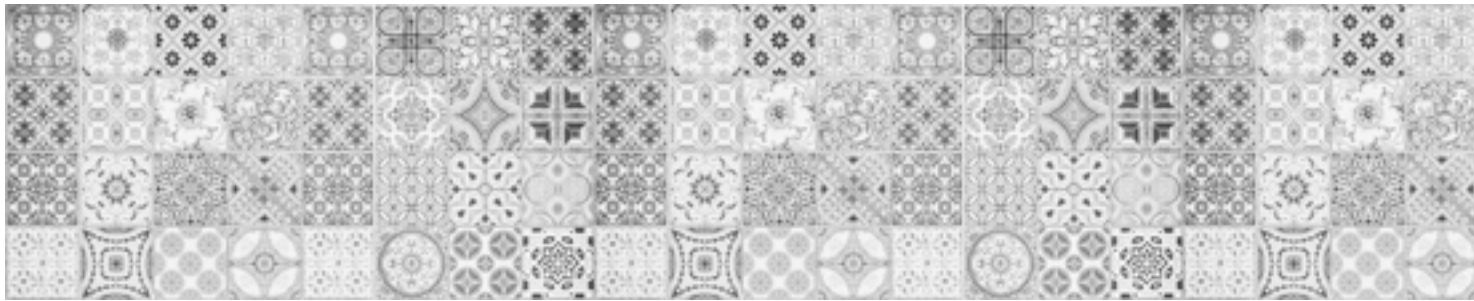

WP1272



WP1308



WP1270



WP1896



WP1312



WP1974



WP2004



WP1868



WP1906



WP1872



WP1908



WP1128





WP2000



WP1188



WP1122



WP1256

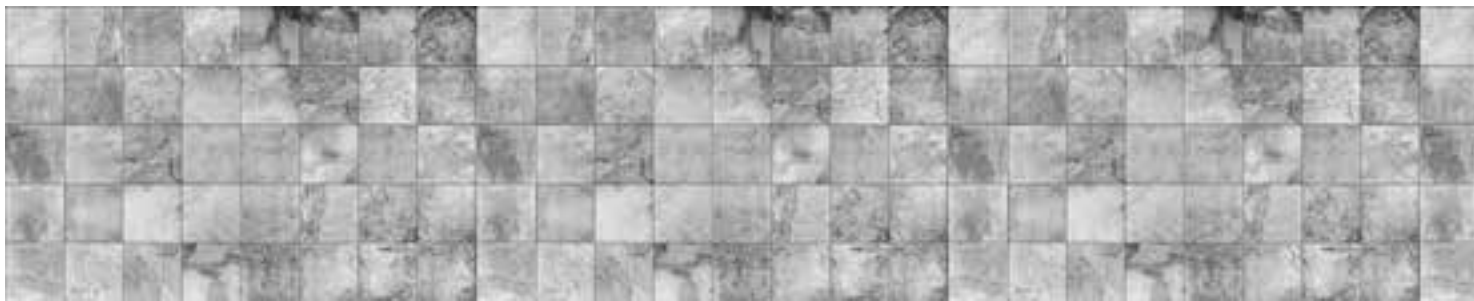

WP1306

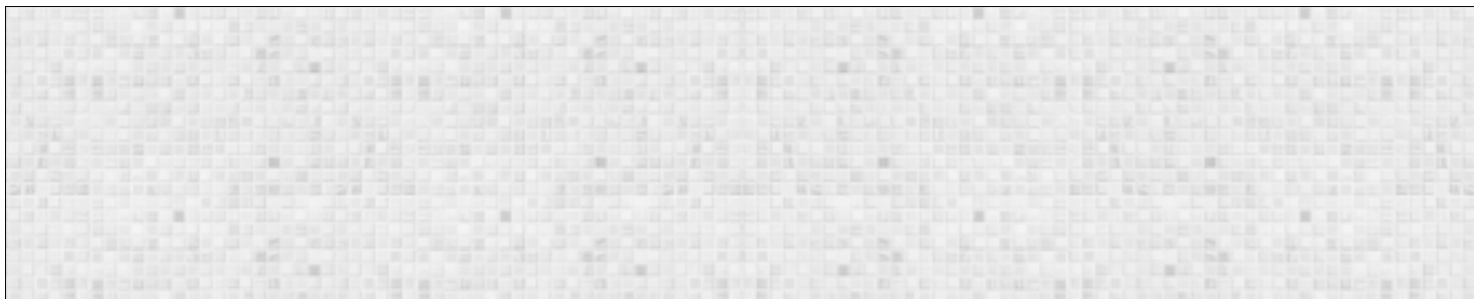

WP1298



WP1898



WP1350



WALLPANEL CLASSIC
WP1348

*Wall Panel su tutta la parete.
Muro bianco con effetto
intonaco rigato.*

*Wall Panel on the entire wall.
White wall with striped plaster effect.*

*Wall Panel sur tout le mur.
Mur blanc avec effet plâtre rayé.*



WP1348



WP1174







WP1190



WP1866



WP1202



WP1200



WP1192



WP1870



WP1204





WP1010



WP1004



WP1014



WP1006



WP2026



WP1820



WP1984



WP1982



WP2016



WP1950

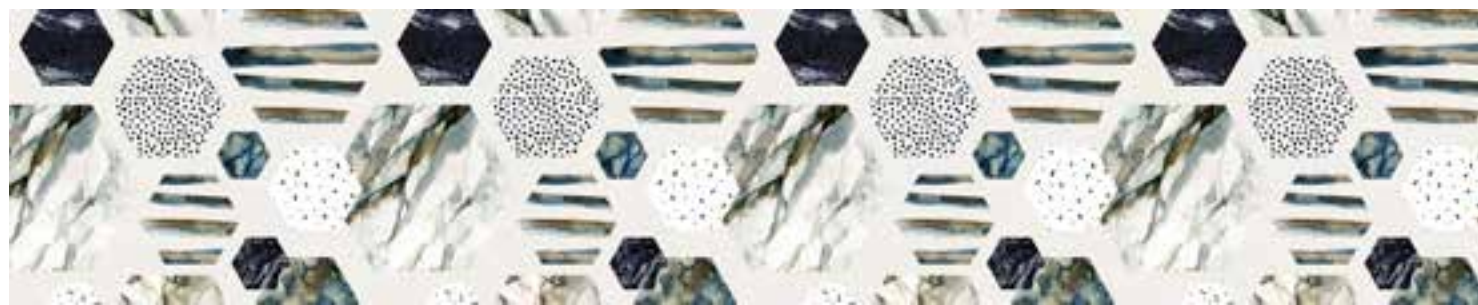

WP1828



WP1966







WP2002



WP1976



WP1968



WP2024



WP2096



WP1152



WP1112

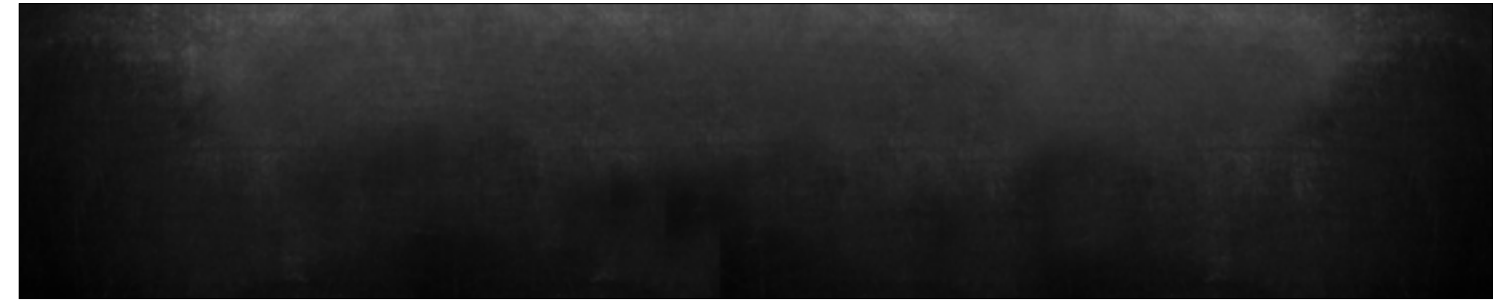

WP2098



WP1150



WP1138

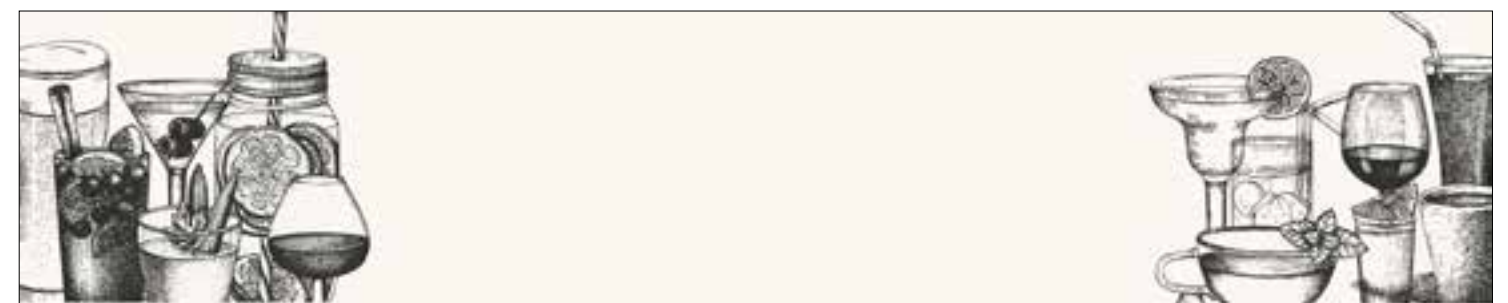

WP1140



WP1160

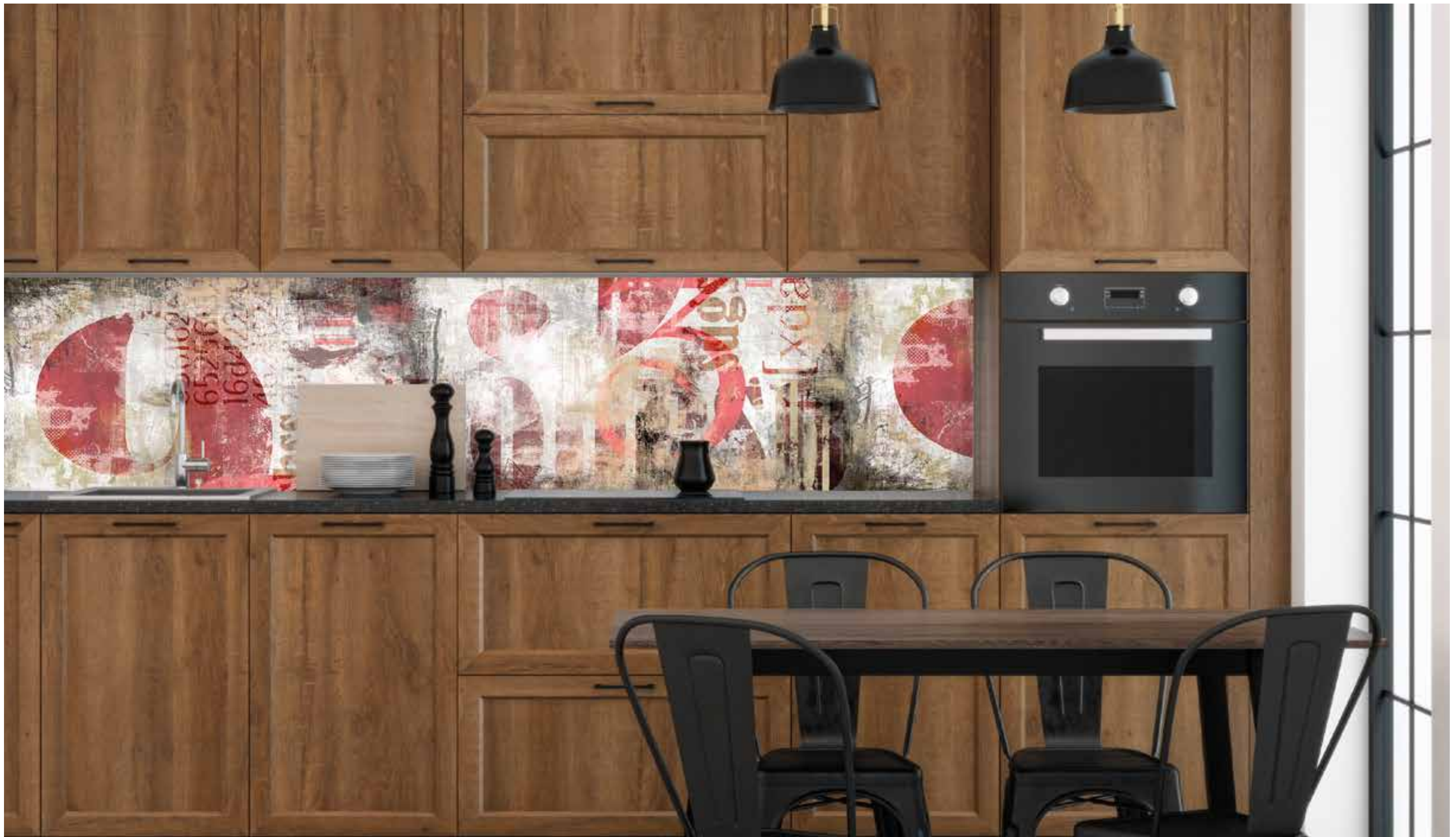

WP1126

*Pannello grafico che
richiama lo stile industriale
della cucina.*

*Graphic panel that recalls
the industrial style
of the kitchen.*

*Panneau graphique
qui évoque le style industriel
de la cuisine.*



WP1824



WP1104



WP1826



WP1146



WP1144



WP1148



WP1970



WP1848



WP1986



WP1988



WP1912



WP1162



WP1834



WP1136



WP1132



WP1164

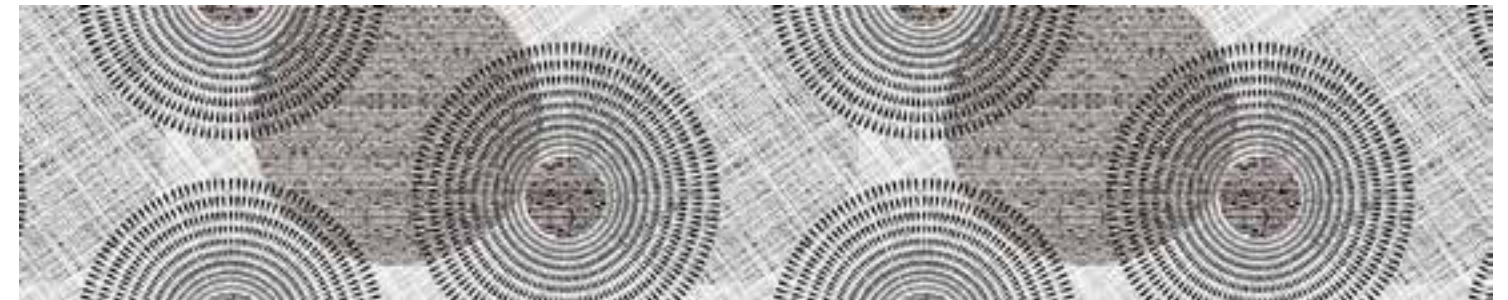

WP1840



WP1832



WP1978



WP1914



WALL PANEL CLASSIC
WP1170

*L'illusione ottica sulla parete
crea un effetto tridimensionale.*

*The optical illusion on the wall
creates a three-dimensional effect.*

*L'illusion d'optique sur le mur
créé un effet tridimensionnel.*



WP1170



WP1172



WP1178



WP1176

WALL PANEL CLASSIC TINTA UNITA

Per i Wall Panel CLASSIC, i nostri designer hanno creato una selezione di tinte Ral, scegliendo colori facilmente abbinabili e tenendo conto delle tendenze attuali.

Per il tuo Wall Panel RAL personalizzato, vedi pagina 163

PLAIN COLORED WALL PANEL CLASSIC

Our designers have created a selection of Ral colors for the CLASSIC Wall Panel

by choosing easily matched colors according to the current trends.

For your customized RAL Wall Panel, see page 163

WALL PANEL CLASSIC EN COULEUR UNIE

Nos designers ont créé une sélection de couleurs RAL pour le Wall Panel CLASSIC

en choisissant des couleurs facilement assorties selon des tendances actuelles

Pour votre panneau RAL personnalisé, voir à la page 163



RAL 1004
GIALLO ORO



RAL 3016
ROSSO CORALLO



RAL 5020
BLU OCEANO



RAL 6021
VERDE PALLIDO



RAL 7024
GRIGIO GRAFITE



RAL 1015
AVORIO CHIARO

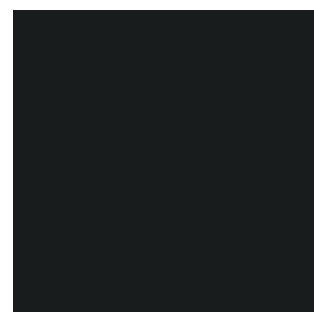

RAL 7016
GRIGIO ANTRALCITE

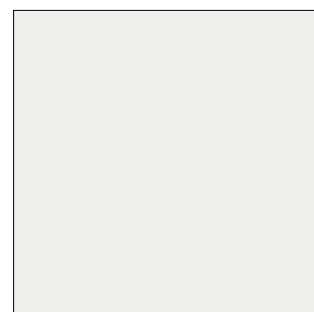

RAL 9016
BIANCO TRAFFICO

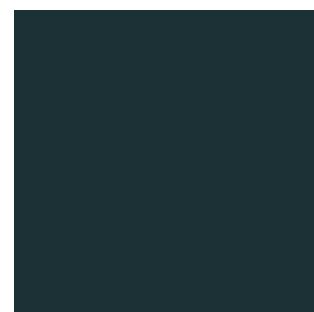

RAL 5001
BLU VERDASTRO



OPTIONAL LAVAGNA

Tutti i Wall Panel CLASSIC possono diventare scrivibili.

Grazie ad un trattamento speciale è possibile scrivere e cancellare su tutto il pannello.

Basta indicare al momento dell'ordine il codice del Wall Panel CLASSIC scelto con optional LAVAGNA.

Questo optional ha un costo aggiuntivo visionabile nel listino prezzi.

Per tutti i pannelli con optional LAVAGNA sono inclusi pennarello e cancellino.

Per la scrittura non utilizzare pennarelli indelebili.

BLACKBOARD OPTIONAL

All CLASSIC Wall Panels can become writable.

Thanks to a special treatment, it is possible to write and erase all over the panel.

It is necessary to mark the code of the chosen Wall Panel CLASSIC with BLACKBOARD optional.

This will have an additional cost to be found in the price list.

Felt pen and eraser are included for all Wall panels with BLACKBOARD optional.

Do not use permanent markers to write on.

TABLEAU NOIR OPTIONEL

Tous les Wall panel CLASSIC peuvent devenir inscriptibles.

Grâce à un traitement spécial, il est possible d'écrire et d'effacer sur tout le panneau.

Lors de la commande, il faut simplement indiquer le code de Wall panel CLASSIC choisi avec la finition

TABLEAU NOIR en option.

Cette option a un coût supplémentaire à vérifier dans la liste de prix.

Un marqueur et une gomme sont inclus pour tous les Wall panel avec TABLEAU NOIR en option.

N'utilisez pas de marqueurs indélébile pour écrire.



OPTIONAL LUCIDO

Per un Wall Panel particolarmente d'effetto è possibile aggiungere l'Optional LUCIDO.

La finitura con effetto lucido rende il Wall Panel brillante e riflettente.

Particolarmente indicato per i pannelli con effetto marmo o piastrelle.

Basta indicare al momento dell'ordine il codice del Wall Panel scelto con optional LUCIDO.

Questo optional ha un costo aggiuntivo visionabile nel listino prezzi.

GLOSSY FINISH OPTIONAL

It is possible to add the GLOSSY finish option for a particularly impressive Wall Panel.

The glossy finish makes the Wall Panel bright and reflective. Therefore it is particularly suitable for panels with a marble or tile effect.

It is necessary to mark the chosen Wall Panel code with the GLOSSY finish option when ordering.

This option has an additional cost to be found in the price list.

FINITION BRILLANTE OPTIONNELLE

Pour une crédence avec un effet particulier, il est possible ajouter la finition BRILLANTE en option.

Cette finition rend le panneau brillant et réfléchissant et donc est particulièrement indiquée pour des panneaux avec un effet marbre ou carrelage.

Lors de la commande, il faut simplement indiquer le code de Wall panel choisi avec la finition BRILLANTE en option.

Cette option a un coût supplémentaire à vérifier dans la liste de prix.



WALL PANEL MAGNETIC

I Wall Panel MAGNETIC sono pannelli metallici stampati in alta definizione e protetti in superficie da un trattamento con finitura opaca. La loro struttura metallica permette la facile applicazione di qualunque accessorio magnetico presente in commercio, nessuna necessità di fori sul pannello e la possibilità di spostare liberamente gli accessori magnetici.

Possono essere stampati con qualunque immagine presente nei Wall Panel CLASSIC o con immagini personalizzate.

Basta indicare al momento dell'ordine il codice del Wall Panel CLASSIC scelto indicando MAGNETIC, ad esempio WPMAGNETIC1020. Per i Wall Panel MAGNETIC è possibile richiedere gli optional LAVAGNA e LUCIDO.

Prestare sempre attenzione quando si posizionano o rimuovono gli accessori per evitare di danneggiare il pannello.

IL PANNELLO METALLICO NON SI PRESTA AD ESSERE TAGLIATO CON ATTREZZI PER IL "FAI DA TE". PERTANTO IN CASO SI ABBA NECESSITÀ DI PARTICOLARI SAGOMATURE, È NECESSARIO RICHIEDERLE AL MOMENTO DELL'ORDINE COSÌ CHE POSSIAMO EFFETTUARE NOI IL TAGLIO CON ATTREZZATURA PROFESSIONALE.

Spessore complessivo mm. 1,5, dimensione massima cm. 300 × 125 (singolo pannello), peso 12 kg/m².

MAGNETIC Wall Panels are made of metal, printed in high definition and protected by a matte finish treatment on the surface. Their metal structure allows the easy application of any magnetic accessory easily found on the market: no need for holes on panel and the possibility to move the magnetic accessories freely.

They can be printed with any image available in the CLASSIC Wall Panel or with customized images.

When sending the order, you should just note the chosen CLASSIC panel code indicating MAGNETIC, for example WP1020 MAGNETIC. When ordering, just indicate at the time of order the code of the Wall Panel CLASSIC code chosen indicating MAGNETIC, for example WPMAGNETIC1020.

It is possible to request the optional BLACKBOARD and GLOSSY for MAGNETIC Wall Panel.

Always be careful when placing or removing accessories to avoid damaging the panel.

THE METAL PANEL IS NOT SUITABLE FOR CUTTING WITH "DO-IT-YOURSELF" TOOLS.

THEREFORE IF YOU NEED SPECIAL SHAPES, IT IS NECESSARY TO ASK FOR IT WHEN ORDERING SO AS WE CAN DIRECTLY MAKE THE CUT WITH PROFESSIONAL EQUIPMENT.

Total thickness mm. 1,5, maximum size cm. 300 × 125 (single panel), Weight 12 kg / m².

Les panneaux MAGNETIC sont réalisés en métal, imprimés en haute définition et protégés par un traitement de finition mate en surface. La structure métallique permet une application aisée de tout accessoire magnétique que l'on trouve facilement dans le commerce. Il ne sera plus nécessaire de percer le panneau, les accessoires magnétiques pourront être déplacés librement.

Faites toujours attention lorsque vous placez ou enlevez les accessoires pour éviter d'endommager le panneau.

Tous les décors de la sélection CLASSIC ainsi que les images personnalisées sont compatibles.

Quand on envoie la commande, il suffit d'indiquer le code du panneau CLASSIC choisi en indiquant MAGNETIC, par exemple WPMAGNETIC1020.

Les options TABLEAU NOIR et BRILLANTE sont compatibles avec l'option MAGNETIC

LE PANNELLO METALLICO DOIT ÈTRE DÉCOUPÉ AVEC DU MATÉRIEL PROFESSIONNEL.

PAR CONSÉQUENT, IL EST IMPÉRATIF DE NOUS COMMANDER DIRECTEMENT TOUT FAÇONNAGE SPÉCIAL.

Épaisseur totale mm. 1,5, taille maximale cm. 300 × 125 (panneau unique), Poids 12 kg / m².

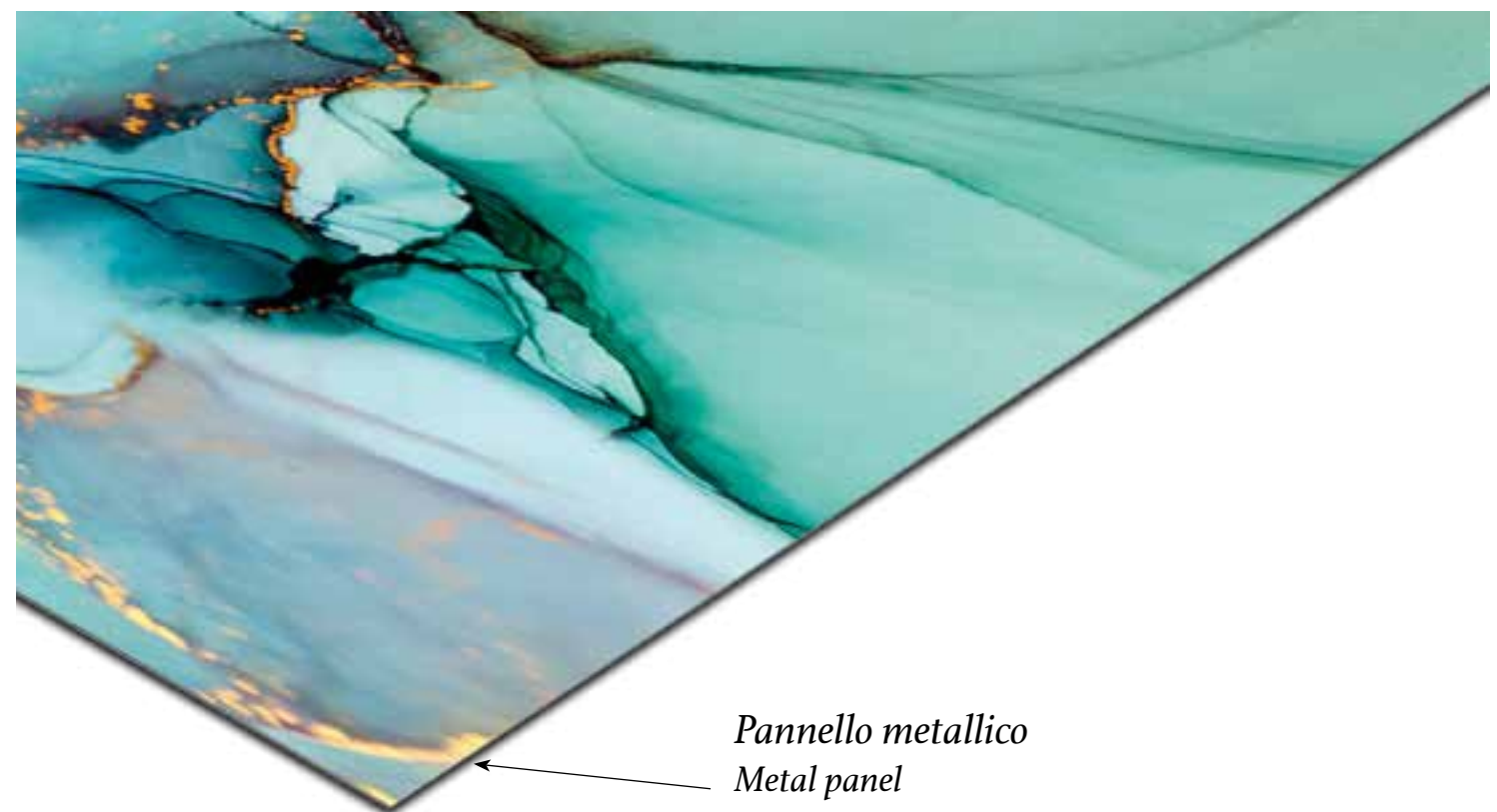

Pannello metallico
Metal panel
Panneau métallique

BARRA APPENDI TUTTO KITCHEN WALL RACK BARRE DE CRÉDENCE



WPBARAPPBI
bianco
white
blanc



WPBARAPPGR
grigio
grey
gris



WPBARAPPNE
nero antracite
charcoal black
noir anthracite



MISURE IN mm
SIZE IN mm
FORMATS EN mm

GANCIO HANGER CROCHET



WPGANCIOBI
bianco
white
blanc



WPGANCIOGR
grigio
grey
gris



WPGANCIONE
nero antracite
charcoal black
noir anthracite



MISURE IN mm
SIZE IN mm
FORMATS EN mm

MENSOLA SHELF ÉTAGÈRE



WPMENSOLABI
bianco
white
blanc



WPMENSOLAGR
grigio
grey
gris



WPMENSOLANE
nero antracite
charcoal black
noir anthracite



MISURE IN mm
SIZE IN mm
FORMATS EN mm

PORTA BICCHIERI GLASS RACK PORTE VERRE MURAL



WPPORBICBI
bianco
white
blanc



WPPORBICGR
grigio
grey
gris



WPPORBICNE
nero antracite
charcoal black
noir anthracite



MISURE IN mm
SIZE IN mm
FORMATS EN mm

PORTA TAZZINE CUP HOLDER PORTE TASSES MURAL



WPPORTAZBI
bianco
white
blanc



WPPORTAZGR
grigio
grey
gris



WPPORTAZNE
nero antracite
charcoal black
noir anthracite



MISURE IN mm
SIZE IN mm
FORMATS EN mm

PORTA ROTOLO KITCHEN ROLL HOLDER PORTE-ROULEAU CUISINE MURA



WPPORROTBI
bianco
white
blanc



WPPORROTGR
grigio
grey
gris



WPPORROTNE
nero antracite
charcoal black
noir anthracite



MISURE IN mm
SIZE IN mm
FORMATS EN mm

PORTA SPEZIE SPICES WALL RACK PORTE ÉPICES MURAL



WPPORSPEBI
bianco
white
blanc



WPPORSPEGR
grigio
grey
gris



WPPORSPENE
nero antracite
charcoal black
noir anthracite



MISURE IN mm
SIZE IN mm
FORMATS EN mm

WALL PANEL 3D

Grazie alla stampa a rilievo i Wall Panel diventano tridimensionali.

Questa particolare tecnica di stampa consente di creare sulla superficie del pannello particolari effetti rilievo percepibili non solo con gli occhi, ma anche con il tatto.

Per i Wall Panel 3D è possibile richiedere solo l'Optional LUCIDO, no l'Optional LAVAGNA.

Thanks to the relief printing, the Wall Panels become three-dimensional. This particular printing technique allows to create some special embossed effects on the panel surface that are visually perceptible, but also to the touch.

It is possible to request only the GLOSSY FINISH Optional, not the BLACK-BOARD Optional.

Grâce à l'impression en relief, les panneaux muraux deviennent tridimensionnels. Cette technique d'impression particulière vous permet de créer des reliefs spéciaux à la surface du panneau qui sont perceptibles visuellement, mais également au toucher.

Seule la finition BRILLANTE est compatible avec l'option 3D.









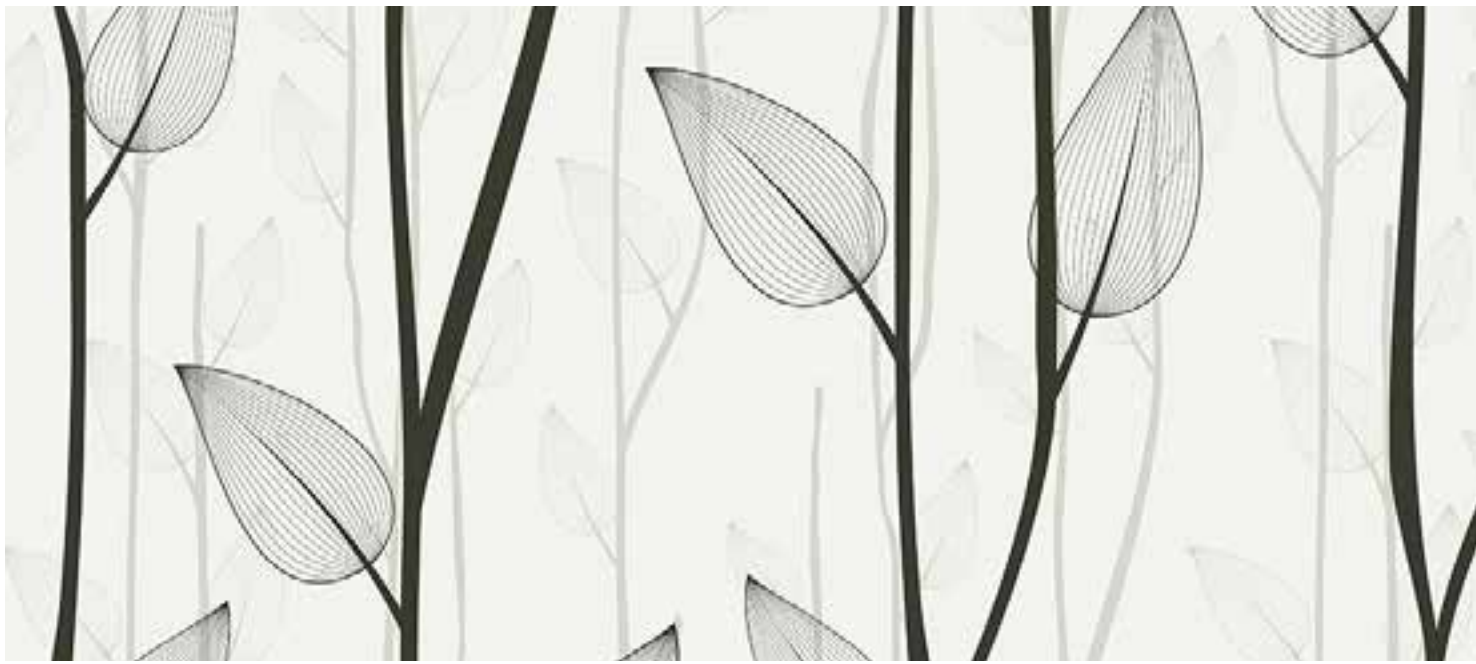

dettaglio detail détail



WP3D1944



dettaglio detail détail



WP3D1928



dettaglio

dettaglio detail détail



WP3D1924



dettaglio detail détail



WP3D1934



dettaglio detail détail

*Sarà un piacere toccare
il pannello e sentire
l'effetto rilievo sulle
venature delle foglie.*

*It will be a pleasure to touch
the panel and feel the embossed
effect on the leaves veins.*

*Ce sera un plaisir de toucher
le panneau et de toucher l'effet
en relief sur les veines des feuilles.*



WP3D2050



dettaglio detail détail



dettaglio detail détail



WP3D1946

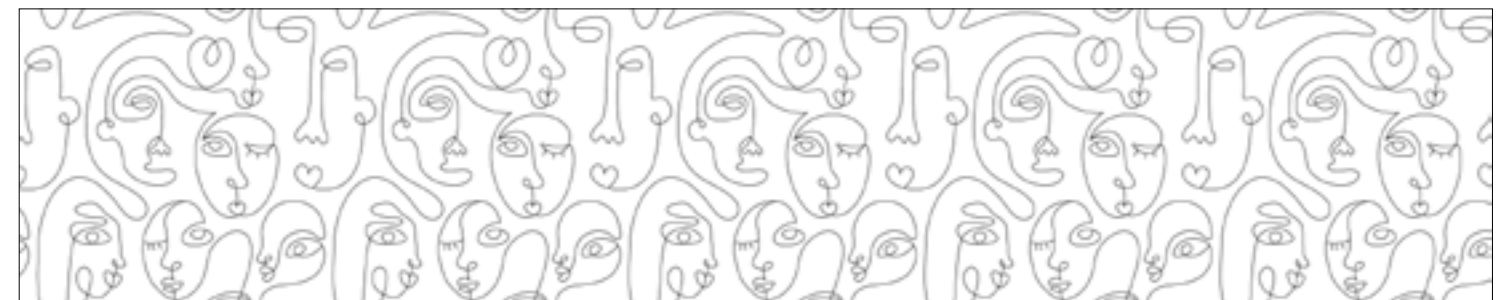

WP3D1930





dettaglio detail détail



WP3D1936



dettaglio detail détail



WP3D2008

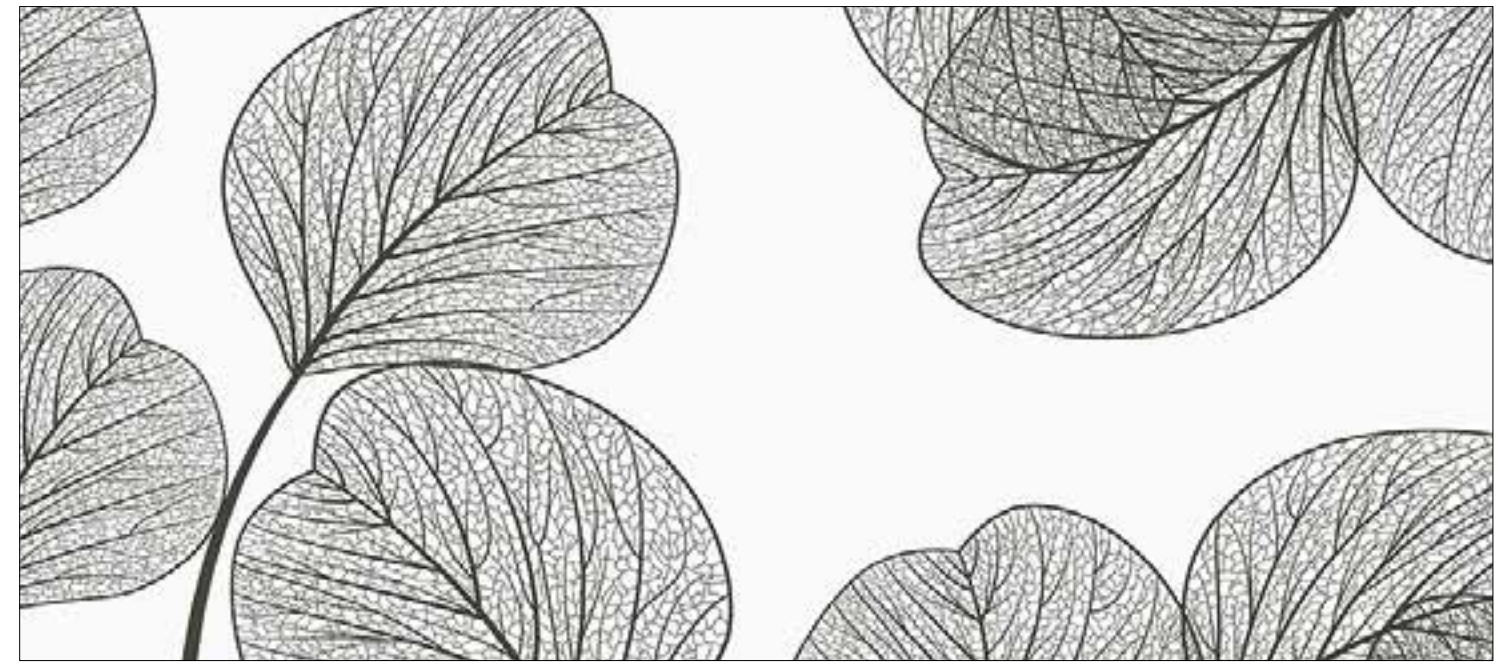

dettaglio detail détail



WP3D2052

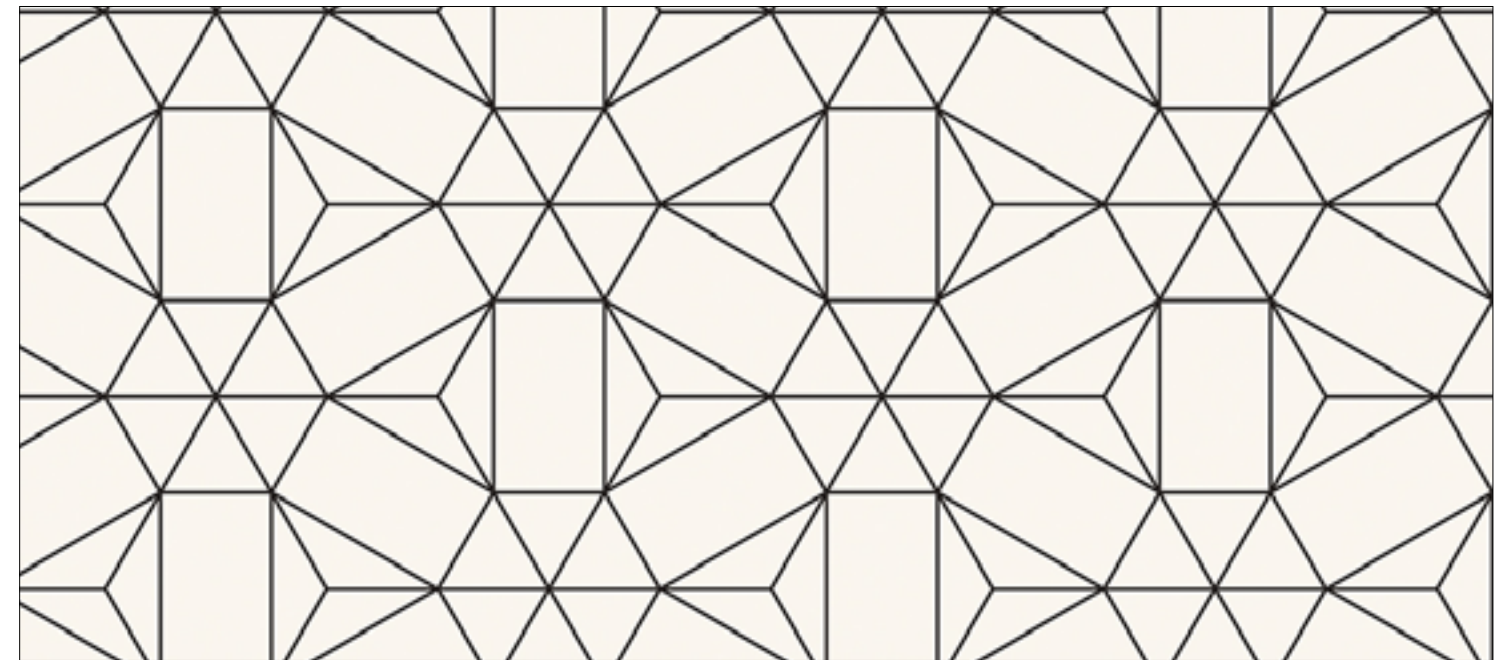

dettaglio detail détail

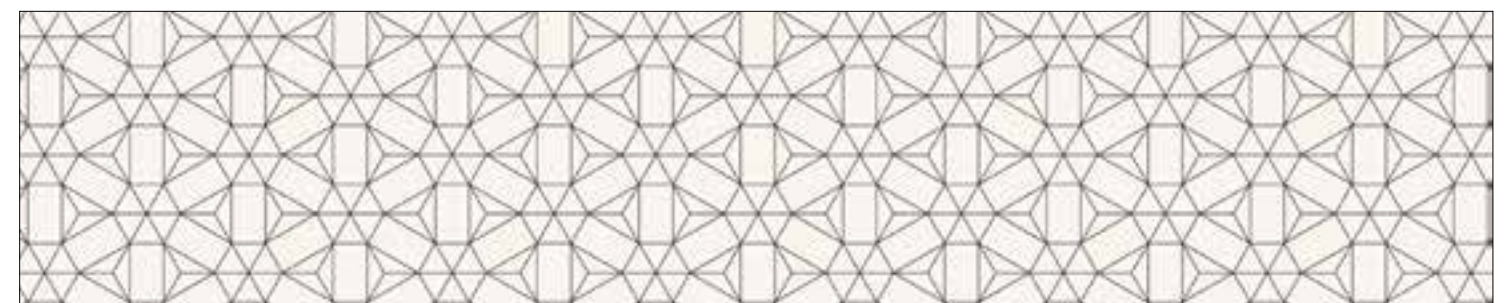

WP3D1940

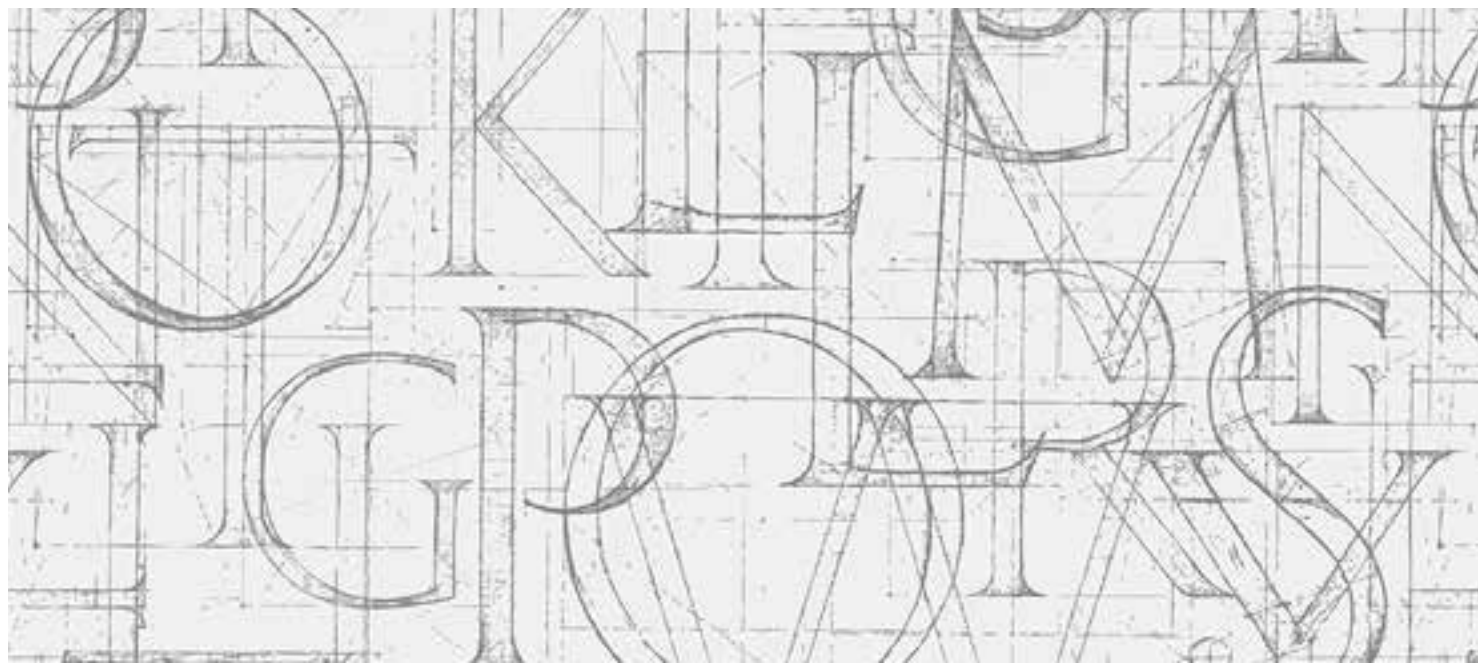

dettaglio detail détail



WP3D1938



dettaglio detail détail



WP3D1932



dettaglio detail détail

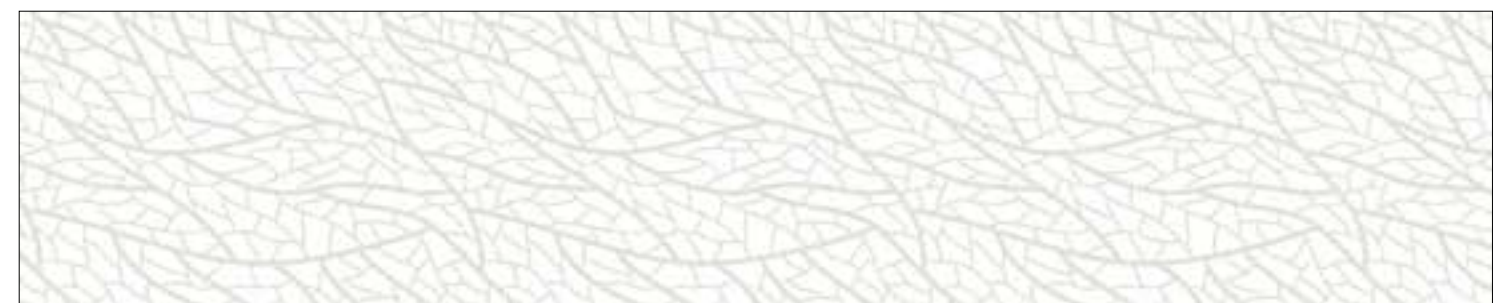

WP3D1942

WALL PANEL **SPECIAL**

Esclusivi pannelli monocromatici con eleganti effetti metallici e non solo...

I nostri classici pannelli formati da due fogli di alluminio che rivestono uno strato in polietilene estruso, diventano speciali grazie ad una superficie particolare e originale.

Some exclusive monochromatic panels with elegant metallic effects and more ... Our classic panels composed by two aluminum sheets that cover a layer of extruded polyethylene, become special thanks to a particular and original surface.

Panneaux monochromes exclusifs avec des effets métalliques élégants et plus encore ... Nos panneaux classiques composés par deux feuilles d'aluminium qui recouvrent une couche de polyéthylène extrudé, deviennent spéciaux grâce à une surface particulière et originale.





WPAS

WALL PANEL ALLUMINIO SPAZZOLATO

Pannello con effetto alluminio spazzolato

WALL PANEL BRUSHED ALUMINUM

Panel with brushed aluminum effect

WALL PANEL alu brossé

Panneau avec effet aluminium brossé



WPSILVER

WALL PANEL ARGENTO

Pannello con effetto metallico color argento semilucido

WALL PANEL SILVER

Panel with semi-glossy silver metallic effect

WALL PANEL ARGENTÉ

Panneau argenté semi-brillant avec effet métallisé



WPRS

WALL PANEL RAME SPAZZOLATO

Pannello con effetto rame spazzolato

WALL PANEL BRUSHED COPPER

Panel with brushed copper effect

WALL PANEL CUIVRE BROSSÉ

Panneau avec effet cuivre brossé



WPNN

WALL PANEL NERO

Pannello bifacciale che presenta un lato di colore nero opaco e un lato di colore nero lucido. In caso di pannello con sagomatura particolare, bisogna indicare al momento dell'ordine quale lato si vuole utilizzare

WALL PANEL BLACK

Double faced panel with a matt black side and the other glossy black. In the case of request for a panel with a particular shape, it is necessary to advise us which side you wish to use when ordering

WALL PANEL NOIR

Panneau double face avec un côté noir mat et l'autre noir brillant. Il faudra préciser le côté visible pour toute commande de forme particulière



WPSP

WALL PANEL SPECCHIO

Pannello con superficie specchiata che crea un effetto specchio perfetto

WALL PANEL MIRROR

Panel with mirrored surface that creates a perfect mirror effect

MIROIR WALL PANEL

Panneau avec surface réfléchissante qui crée un effet miroir parfait

WALL PANEL ARTISTIC

I Wall Panel ARTISTIC vengono decorati a mano dai nostri artisti che fanno di ogni pannello, un pannello unico.

Per le decorazioni vengono utilizzati una resistente lavorazione materica e foglia argento. Al pannello viene applicato il trattamento protettivo che utilizziamo su tutti i nostri Wall Panel, per garantire una protezione totale che dura nel tempo.

Per i Wal Panel ARTISTIC è possibile richiedere solo l'Optional LUCIDO, no l'Optional LAVAGNA.

The ARTISTIC Wall Panel are hand-decorated by our artists which makes each panel unique.

A resistant material treatment and silver foil are used for decorations.

The protective treatment applied to all our panels will guarantee a total protection that lasts over time.

It is possible to request only the GLOSSY FINISH Optional, not the BLACKBOARD Optional.

Les crédences ARTISTIC sont décorées à la main par nos artistes, ce qui rend unique chaque panneau.

Cette décoration est réalisée à l'aide d'un matériau résistant et d'une feuille d'argent. Cette protection garantit au panneau et au décor une longue durée de vie.

Seule la finition BRILLANTE est compatible avec l'option ARTISTIC.





dettaglio detail détail



dettaglio detail détail



WPA2092



WPA2094



150



dettaglio detail détail



WPA2090

151



dettaglio detail détail



WPA2078



dettaglio detail détail



WPA2080

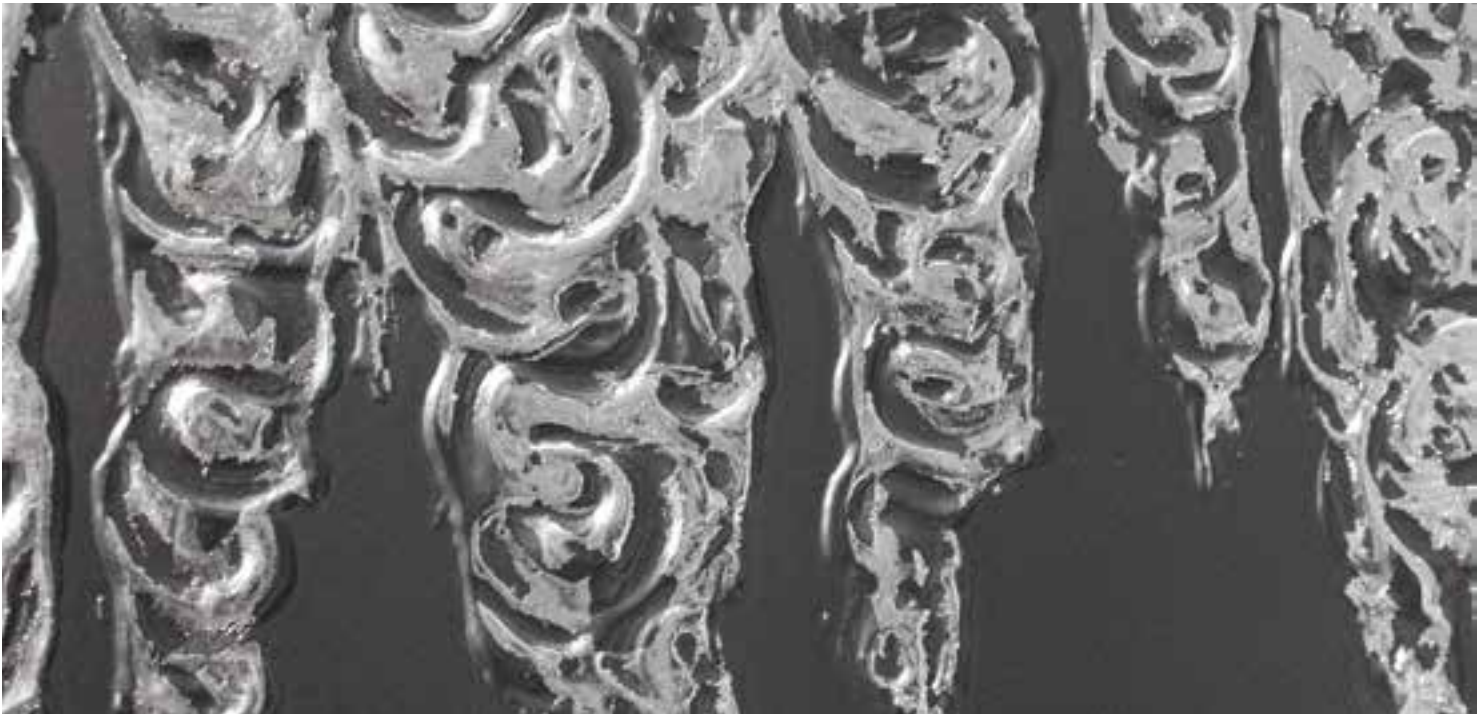

dettaglio detail détail



WPA2082



dettaglio detail détail



WPA2084



dettaglio detail détail



dettaglio detail détail



WPA2086

154



WPA2088

155



dettaglio detail détail



WPA2074



dettaglio detail détail



WPA2072

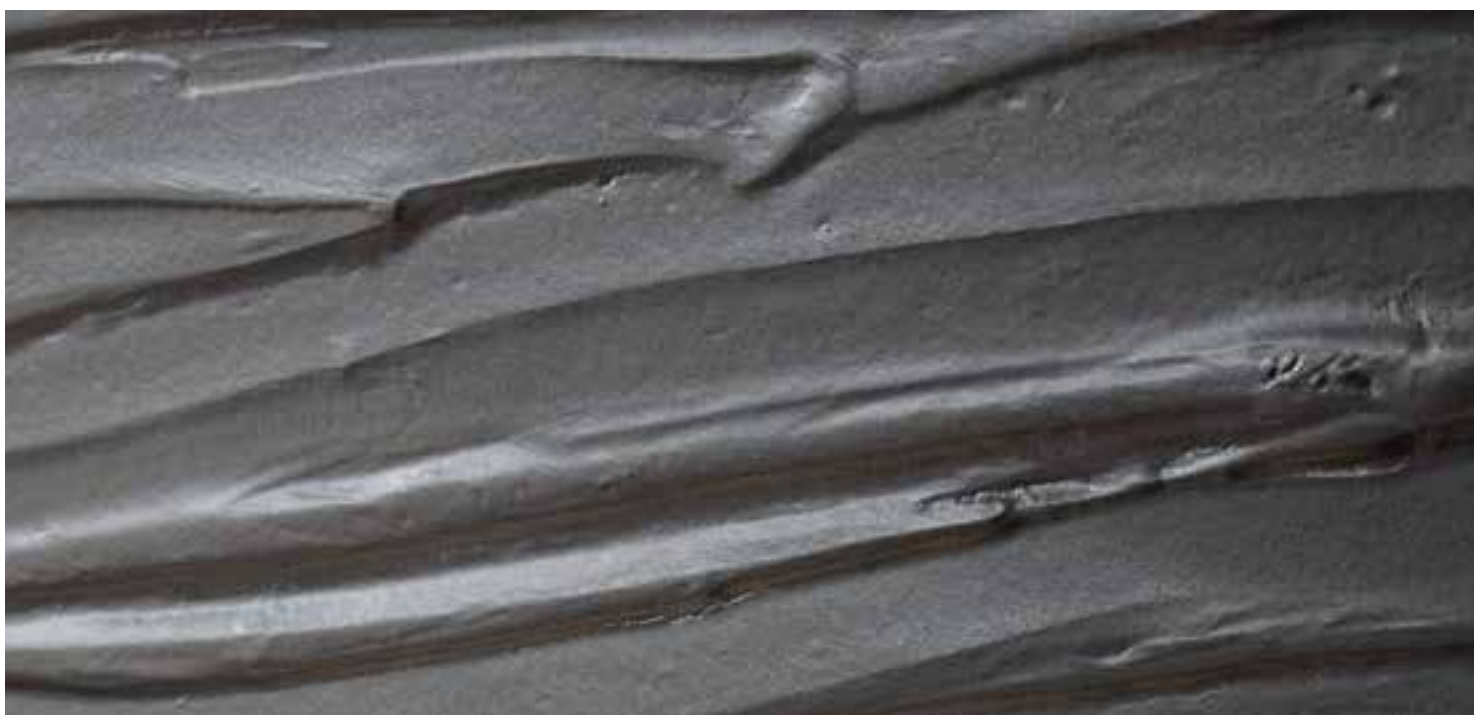

dettaglio detail détail

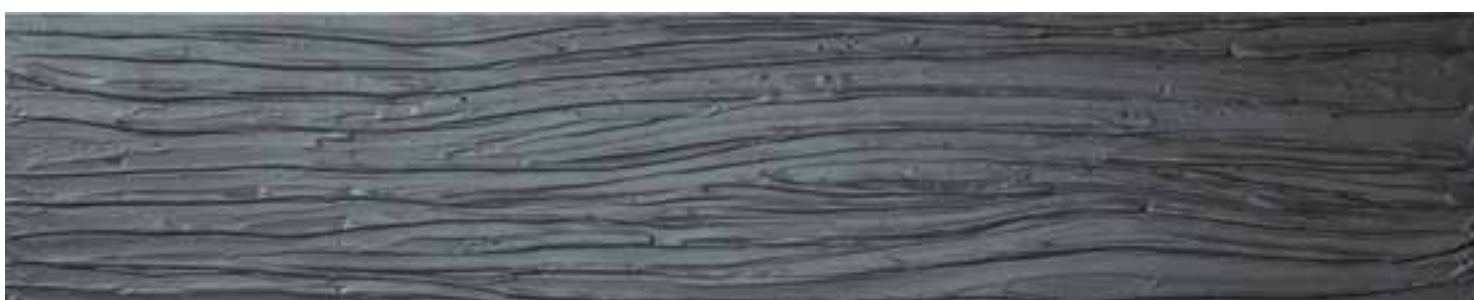

WPA2076



dettaglio detail détail



WPA2070

WALL PANEL BASIC

TEXTURE SELEZIONATE, MISURA STANDARD, PREZZO CONVENIENTE!

I Wall Panel BASIC comprendono una selezione dei nostri pannelli più richiesti, disponibili esclusivamente nella misura standard 300x60 cm.

Tutte le texture sono state create per essere affiancabili in lunghezza, in modo che non si vedano differenze di giunzione nel caso si vogliano montare due pannelli vicini.

Il prezzo di listino è inteso per il singolo pannello.

Non è possibile aggiungere optional, richiedere il taglio su misura e il render dell'immagine.

SELECTED TEXTURES, STANDARD SIZE, SUITABLE PRICE!

The BASIC Wall Panel include a selection of our most popular panels, available exclusively in the standard size 300x60 cm.

All textures have been created to be continued in length, so that no joins can be seen in case you wish to place two panels next to another.

The price refers to the single panel.

It is not possible to add options or ask for any customized cut and image rendering,

TEXTURES SÉLECTIONNÉES, FORMAT STANDARD, PRIX ADEQUAT!

Les crédences Wall Panel BASIC comprennent une sélection de panneaux les plus populaires, disponibles exclusivement dans le format standard cm. 300x60.

Toutes les images ont été pensées pour faire suivre le décor sans joint visible si vous souhaitez poser deux panneaux l'un à côté de l'autre.

Le prix se réfère au panneau single.

Il n'est pas possible d'ajouter des options, de demander une dimension spéciale ou un visuel.

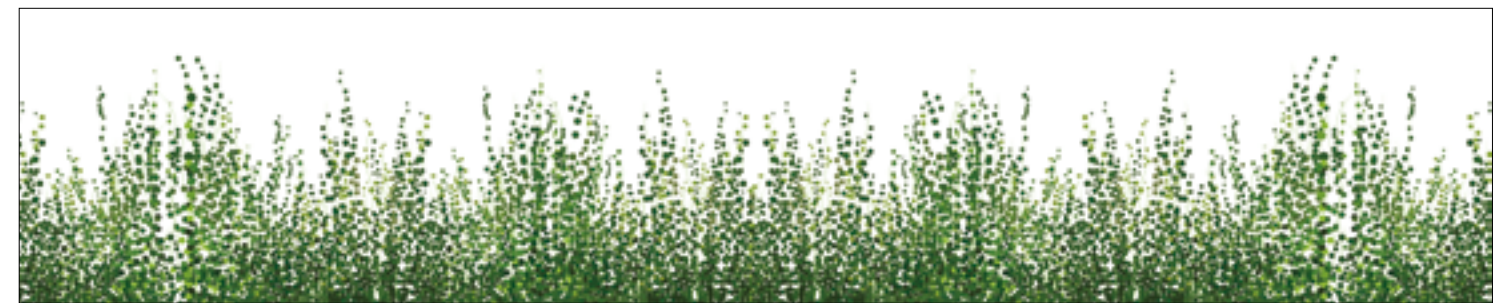

WPB2038



WPB2040



WPB2042



WPB2044



WPB2046



WPB2048

NON SOLO CUCINE

I Wall Panel sono ideali per rinnovare e impreziosire le pareti di tutti gli ambienti. Non solo cucine, ma anche bagni, locali commerciali, uffici... senza dimenticare gli ambienti esterni.

NOT ONLY KITCHENS

The Wall Panels are ideal for renovating and adorning all environments walls. Not only kitchens, but also bathrooms, commercial premises, offices... without forgetting the external settings.

PAS SEULEMENT DES CUISINES

Les panneaux Wall Panel sont idéaux pour rénover et embellir les murs de tous milieux. Pas seulement des cuisines, mais aussi des salles de bain, locaux commerciaux, bureaux... sans oublier les environnements à l'extérieur.



WP1916



WP1270



WP1152



WP1828



WP1122



WP1844

WALL PANEL PERSONALIZZAZIONI CUSTOMIZED PERSONNALISATIONS



PINTDECOR®
WALLPANEL
MADE IN ITALY

GUARDA IL VIDEO SU
COME PERSONALIZZARE
IL TUO WALL PANEL

WATCH THE VIDEO ON HOW
TO CUSTOMIZE
YOUR WALL PANEL

<https://youtu.be/yhcXz48wYx0>



YouTube

LIBERA LA TUA CREATIVITA': PERSONALIZZA IL TUO WALL PANEL

Hai un'idea e non riesci a realizzarla? Desideri un'immagine che non trovi nel catalogo? Con Pintdecor Wall Panel puoi scegliere l'immagine giusta tra migliaia di proposte sul sito www.shutterstock.com. Dopo aver trovato quello che cerchi, devi solo comunicarci il codice ID dell'immagine scelta e le misure del pannello che vuoi realizzare: in poco tempo riceverai il preventivo ed un render in scala con la tua immagine.

Sul Wall Panel è possibile stampare anche una tua foto personale con la misura che desideri: il servizio è completamente gratuito. Guarda il video tutorial Wall Panel su YouTube

<https://youtu.be/yhcXz48wYxo> oppure contatta il nostro servizio clienti per maggiori informazioni.

FREE YOUR CREATIVITY: CUSTOMIZE YOUR WALL PANEL

You have an idea, but can't you make it? Do you like an image, but you do not find it in the catalog? You can choose the right subject among thousands of proposals on www.shutterstock.com site. After finding what you are looking for, you should just tell us the ID code of it and the panel sizes you wish to realize. In a short time you will receive a quotation and a scale render with your image.

You can also print your own personal photo with the desired size on the Wall Panel: the service is completely free.

Watch the tutorial Wall Panel video on YouTube <https://youtu.be/yhcXz48wYxo> or contact our customer service for additional information.

LIBÉREZ VOTRE CRÉATIVITÉ: PERSONNALISEZ VOTRE CRÉDENCE

Avez-Vous une idée et Vous ne pouvez pas la réaliser? Voulez-Vous une image qui n'est pas dans le catalogue?

Vous pouvez choisir votre photo parmi toute la banque d'images du site www.shutterstock.com.

Une fois votre image sélectionnée, il vous suffit de nous communiquer sa référence et les dimensions de la crédence à réaliser. Nous vous transmettrons un rendu à l'échelle ainsi qu'un chiffrage dans les plus brefs délais. Vous pouvez également nous envoyer votre propre photo sur la crédence avec la taille souhaitée, le service est totalement gratuit! Regardez la vidéo des crédences sur YouTube <https://youtu.be/yhcXz48wYxo> ou contactez notre Service client pour plus d'informations.



PINTDECOR®
WALLPANEL
MADE IN ITALY

SCEGLI IL COLORE CHE PREFERISCI PER IL TUO PANNELLO IN TINTA UNITA!

Pintdecor mette a disposizione un servizio personalizzato che ti permette di scegliere il colore che desideri. Ti basterà scegliere tra i tanti colori disponibili nella cartella Ral, quello più adatto alle tue esigenze di arredo. Dopo averci comunicato il codice Ral del colore e le misure del pannello da realizzare, riceverai in poco tempo il preventivo e un Render in scala del tuo pannello. Il servizio è completamente gratuito.

Per maggiori informazioni contatta il nostro servizio clienti.

CHOOSE THE COLOR YOU PREFER FOR YOUR PLAIN COLOR PANEL!

Pintdecor provides a customized service that allows you to choose the plain color you wish. It is simple, you have just to choose the one which best suits your furnishing needs among the many colors available in Ral chart. After having advised us on the Ral code and the panel sizes, you will receive a quotation and a scale render of your panel in a short time. The service is completely free.

Please contact our customer service for more information.

CHOISISSEZ LA COULEUR QUE VOUS PRÉFÉREZ POUR VOTRE CREDENCE EN COULEUR UNIE!

Pintdecor propose un service personnalisé qui vous permet de choisir la couleur que vous souhaitez.

On peut choisir parmi les nombreuses couleurs disponibles dans les nuanciers RAL.

Il vous suffit de nous communiquer la référence RAL et les dimensions de la crédence à réaliser.

Nous vous transmettrons un rendu à l'échelle ainsi qu'un chiffrage dans les plus brefs délais.

Le service est entièrement gratuit!

Contactez notre service client pour plus d'informations.

WALL PANEL EXTRA

MAZZETTA CAMPIONARIO WALL PANEL code WPCAMP1515

Nella mazzetta campionario troverete una selezione di 8 pannelli nel formato cm.15x15 scelti tra alcune tipologie di Wall Panel. Sono presenti: n° 1 WP1020 con finitura opaca - n° 1 WP1248 con finitura lucida - n° 1 WP3DI944 - n° 1 WPAS - n° 1 WPSILVER - n° 1 WPRS - n° 1 WPNN - n° 1 WPSP. Il prezzo della mazzetta è visibile nel listino prezzi.

WALL PANEL SAMPLES BOOKLET code WPCAMP1515

In this booklet you will find a selection of 8 panels in size cm.15x15 chosen from some different types of Wall Panels. There are: n° 1 WP1020 with matt finish - n° 1 WP1248 with glossy finish - n° 1 WP3DI944 - n° 1 WPAS - n° 1 WPSILVER - n° 1 WPRS - n° 1 WPNN - n° 1 WPSP. The price can be seen in the price list.

NUANCIER ÉCHANTILLONS WALL PANEL code WPCAMP1515

Vous trouverez une sélection de 8 panneaux en format cm.15x15 choisis parmi différents sortes de panneaux dans le nuancier d'échantillons qui sont les suivants: n° 1 WP1020 avec finition mate - n° 1 WP1248 avec finition brillante - n° 1 WP3DI944 - n° 1 WPAS - n° 1 WPSILVER - n° 1 WPRS - n° 1 WPNN - n° 1 WPSP. Vous trouverez son tarif dans la liste de prix.

code WPCAMP1515



code WPESPOTAV



ESPOSITORE DA TAVOLO CON CAMPIONARIO code WPESPOTAV

Elegante espositore da tavolo con finitura bianco opaco che contiene una selezione di 10 pannelli nel formato A4 scelti tra alcune tipologie di Wall Panel. Sono presenti: n° 1 WP1020 con finitura opaca - n° 1 WP1248 con finitura lucida - n° 1 WP3DI944 - n° 1 WPAS - n° 1 WPSILVER - n° 1 WPRS - n° 1 WPNN - n° 1 WPSP - n° 1 WPA2076 - n° 1 RAL con finitura opaca. Il prezzo dell'espositore è visibile nel listino prezzi.

TABLE DISPLAY WITH SAMPLES code WPESPOTAV

An elegant table display with a matt white finish that contains a selection of 10 panels in A4 size chosen from some different types of Wall Panel. There are: n° 1 WP1020 with matt finish - n° 1 WP1248 with glossy finish - n° 1 WP3DI944 - n° 1 WPAS - n° 1 WPSILVER - n° 1 WPRS - n° 1 WPNN - n° 1 WPSP - n° 1 WPA2076 - n° 1 RAL with matt finish. Its price can be checked in the price list.

PRÉSENTOIR DE BUREAU AVEC ÉCHANTILLONS code WPESPOTAV

Un élégant présentoir de bureau en finition blanche mate qui contient une sélection de 10 panneaux en format A4 choisis parmi différents sortes de panneaux et qui sont les suivants: n° 1 WP1020 avec finition mate - n° 1 WP1248 avec finition brillante - n° 1 WP3DI944 - n° 1 WPAS - n° 1 WPSILVER - n° 1 WPRS - n° 1 WPNN - n° 1 WPSP - n° 1 WPA2076 - n° 1 panneau RAL avec finition mate. Vous trouverez son tarif dans la liste de prix.

CAMPIONE Wall Panel code WPCAMP5030

Il Campione Wall Panel è un pannello di misura cm. 50x30 che può essere richiesto con qualunque codice presente nel catalogo, anche con l'aggiunta di Optional. Se si desidera visionare un Wall Panel prima dell'acquisto e questo non è presente nei campionari proposti, il pannello Campione è la soluzione ideale.

Il prezzo di un singolo pannello è visionabile nel listino prezzi.

Wall Panel SAMPLE code WPCAMP5030

The Sample Wall Panel is a panel in size cm. 50x30 which can be requested with any code in the catalog, even with the Optional addition. If you wish to check a Wall Panel before ordering and this is not present in the proposed samples, the Sample panel is the ideal solution.

The single panel price can be found in the price list.

ECHANTILLON Wall Panel code WPCAMP5030

L'échantillon Wall Panel est un panneau en format cm. 50x30 qui peut être demandé avec n'importe quelle référence du catalogue, options comprises. Le panneau ECHANTILLON est la solution idéale si vous souhaitez visualiser un panneau avant de l'acheter.

Vous trouverez son tarif dans la liste de prix.

code WPCAMP5030



PROFILO IN ACCIAIO code WPPROF

Per la copertura dei bordi laterali del Wall Panel è disponibile il profilo in acciaio Inox cromato. L'altezza del profilo è 4,5 mm ed è possibile richiedere la lunghezza personalizzata, massimo 270 cm. Il prezzo al metro lineare è visionabile nel listino prezzi.

STEEL PROFILE code WPPROF

The chromed stainless steel profile is available to cover the Wall Panel edges. The profile height of is 4,5mm and it is possible to request a customized length, maximum 270 cm. The price per linear meter can be viewed in the price list.

PROFIL EN ACIER code WPPROF

Le profilé en acier inoxydable chromé est disponible pour recouvrir les bords latéraux des panneaux. La hauteur du profil est de 4,5 mm et il est possible de demander une longueur personnalisée, maximum 270cm. Vous trouverez son tarif au mètre linéaire dans la liste de prix.



code WPPROF



GLASS PANEL PARASCHIZZI

GLASS PANEL SPLASHBACK

GLASS PANEL CRÉDENCES VERRE



GLASS PANEL GP1574

I Glass Panel sono realizzati per essere posizionati dietro i piani cottura allo scopo di abbellire la cucina e proteggere il muro da schizzi e sporco.

Sono composti da una lastra di vetro temperato extra chiaro che ha uno spessore di 4 mm.

La stampa ad alta risoluzione viene effettuata sul retro della lastra per ottenere colori ancora più intensi e brillanti che durano nel tempo.

Tutti i Glass Panel sono anti graffio, lavabili, resistenti agli sbalzi di temperatura e ai raggi UV.

Possono essere posizionati dietro piani cottura elettrici, in vitroceramica e ad induzione.

**NON SONO ADATTI PER ESSERE POSIZIONATI DIETRO I PIANI COTTURA
CON BRUCIATORE A TRIPLA CORONA POSTERIORE.**

Misure disponibili: cm. 100 × 45 - cm. 80 × 45

The Glass Panels are designed to be placed behind the cooktops in order to adorn the kitchen and protect the wall from splashes and dirt. They are composed by a sheet of extra clear tempered glass with a 4 mm thickness.

High resolution printing is performed on the glass backside to obtain even more intense and brilliant colors that last over time.

All Glass Panels are anti-scratch, washable, resistant to sudden changes in temperature and UV rays.

They can be placed behind electric, glass ceramic and induction cooktops.

**THEY ARE NOT SUITABLE TO BE PLACED BEHIND THE COOKTOPS
WITH A REAR TRIPLE CROWN BURNER.**

Available sizes: cm. 100 × 45 - cm. 80 × 45

Les crédences en verre Glass Panel sont réalisées pour être placées derrière les plaques de cuisson afin de décorer votre cuisine et protéger le mur des éclaboussures et saletés. Il s'agit d'un verre trempé transparent de 4mm d'épaisseur. L'impression en haute résolution est réalisée au dos du verre pour obtenir des couleurs encore plus intenses et brillantes avec une plus longue durée de vie. Toutes les crédences en verre sont anti-rayures, lavables, résistantes aux écarts de températures et aux rayons UV.

Elles peuvent être placées derrière des plaques électriques, vitrocéramiques et à induction.

Elles peuvent être placées derrière des plaques électriques, vitrocéramiques et à induction.

Elles peuvent être placées derrière des plaques électriques, vitrocéramiques et à induction.

**ELLES NE PEUVENT PAS ÊTRE PLACÉES DERRIÈRE DES PLAQUES GAZ
AVEC UNE TRIPLE COURONNE À L'ARRIÈRE.**

Formats disponibles: cm. 100 x 45 - cm. 80 x 45





GP1574 - 100x45



GP1576 - 80x45



GP1442 - 100x45



GP1444 - 80x45



GP1562 - 100x45



GP1564 - 80x45



GP1446 - 100x45



GP1448 - 80x45



GP1414 - 100x45



GP1416 - 80x45



GP1486 - 100x45



GP1488 - 80x45



GP1434 - 100x45



GP1436 - 80x45



GP1514 - 100x45



GP1516 - 80x45





GP1534 - 100x45



GP1536 - 80x45



GP1698 - 100x45



GP1700 - 80x45



GP1542 - 100x45



GP1544 - 80x45



GP1714 - 100x45



GP1716 - 80x45



GP1546 - 100x45



GP1548 - 80x45



GP1718 - 100x45



GP1720 - 80x45

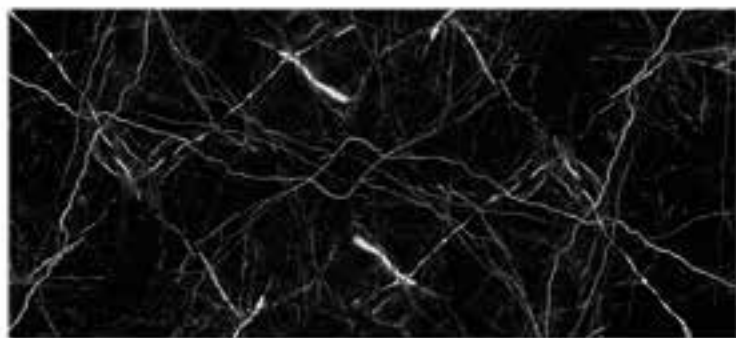

GP1690 - 100x45

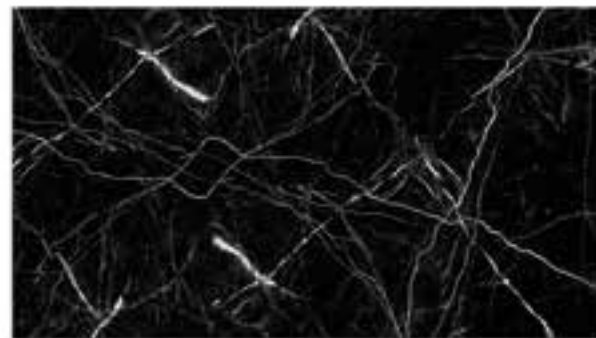

GP1692 - 80x45



GP1730 - 100x45



GP1732 - 80x45



GP1998 - 100x45



GP2000 - 80x45



GP1962 - 100x45



GP1964 - 80x45



GP1950 - 100x45

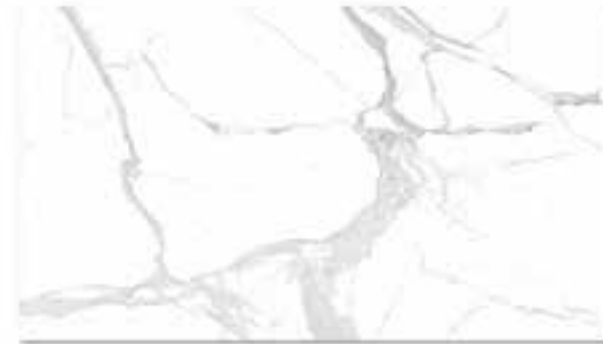

GP1952 - 80x45



GP1966 - 100x45



GP1968 - 80x45



GP1954 - 100x45



GP1956 - 80x45



GP1970 - 100x45



GP1972 - 80x45



GP1958 - 100x45



GP1960 - 80x45



GP1974 - 100x45



GP1976 - 80x45



GP1978 - 100x45



GP1980 - 80x45



GP1986 - 100x45



GP1988 - 80x45



GP1990 - 100x45



GP1992 - 80x45



GP1982 - 100x45



GP1984 - 80x45



GP1994 - 100x45



GP1996 - 80x45

WALL PANEL

ISTRUZIONI DI MONTAGGIO - ASSEMBLY INSTRUCTIONS - NOTICE DE MONTAGE



1 CAPOVOLGERE - TURN IT - TOURNER

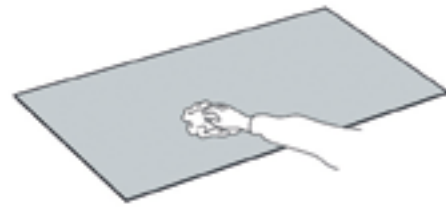

2 PULIRE LA SUPERFICE - CLEAN THE SURFACE
NETTOYER LA SURFACE

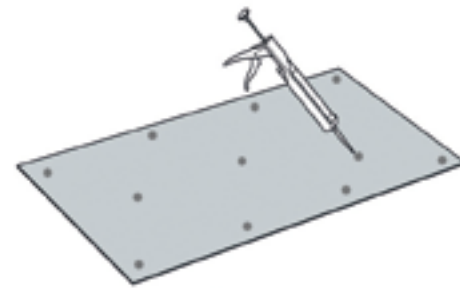

3 SILICONE

PULIRE IL MURO / CLEAN THE WALL



4 PULIRE IL MURO - CLEAN THE WALL
NETTOYER LE MUR



5 ACCOSTARE - PLACE NEAR - RAPPROCHEZ

SPECIFICHE TECNICHE TAGLIO E FORATURA

Per il taglio dei Wall Panel sono ideali gli stessi utensili o macchinari usati per tagliare il legno: sega circolare radiale, seghetto alternativo. Per effettuare dei fori, si consiglia di utilizzare trapano con fresa a tazza o punta da ferro. Non utilizzare il percussore per la foratura.

POSA

Per la posa su pareti nuove, è necessario verificare che il fondo sia asciutto e compatto e la superficie della parete sia piana e pulita, se necessario livellarla e pulirla. Per la posa su pareti già rivestite, è necessario verificare che il rivestimento preesistente sia ben fissato e asciutto. Per installare i Wall Panel, si possono utilizzare silicone oppure adesivi per piastrelle in ceramica. Assicurarsi che l'adesivo steso sulla superficie da rivestire sia sufficiente per tutto il retro dei pannelli.

PULIZIA

Per la pulizia ordinaria è sufficiente l'uso di acqua o detersivi da casa. L'utilizzo di pasta polish risulta efficace nel caso di graffiature superficiali da ripristinare.

TECHNICAL SPECIFICATIONS CUTTING AND DRILLING

For Wall Panel cutting, you can use the same tools or machines to cut the wood, such as radial circular saw, jigsaw. We recommend using a drill with a hole saw blades or iron bits to make a hole in. Do not use a percussion drill for panel drilling.

FITTING

Before laying on new walls, it is necessary to check that the base is dry and compact and the surface is flat and clean. If necessary, you can level and clean it. For laying on covered walls, it is necessary to check that the pre-existing covering is well fastened and dry. Silicone or some adhesives for ceramic tiles can be used to fit the Wall Panel up. Make sure that the adhesive spread on the surface to be coated, is enough for the whole panel back.

CLEANING

It is enough to use water and household products for routine cleaning. A polishing paste can be successfully used in the case of superficial scratches to be restored.

SPECIFICITÉS TECHNIQUES COUPE ET PERCAGE

On peut utiliser les mêmes outils et machine que pour le bois, telles qu'une scie circulaire, radiale ou sauteuse. Nous vous recommandons d'utiliser une perceuse avec une scie cloche ou des mèches en fer pour faire un trou. N'utiliser pas de perceuse à percussion!

MONTAGE

Pour la pose sur de nouveaux murs, il est important vérifier que le fond soit sec et compact et que la surface soit plane et propre, si nécessaire vous pouvez la niveler et la nettoyer. Pour la pose sur des murs déjà enduits, on doit vérifier que le revêtement préexistant soit bien fixé et sec. On peut utiliser du silicone ou des colles pour carreaux de céramique pour la pose. Assurez-vous que l'adhésif vous permette de recouvrir tout le dos du panneau.

NETTOYAGE

On peut utiliser de l'eau et des nettoyants ménagers pour le nettoyage quotidien. De la pâte à polir peut être utilisée en cas de rayure superficielle.

GLASS PANEL

ISTRUZIONI DI MONTAGGIO - ASSEMBLY INSTRUCTIONS - NOTICE DE MONTAGE

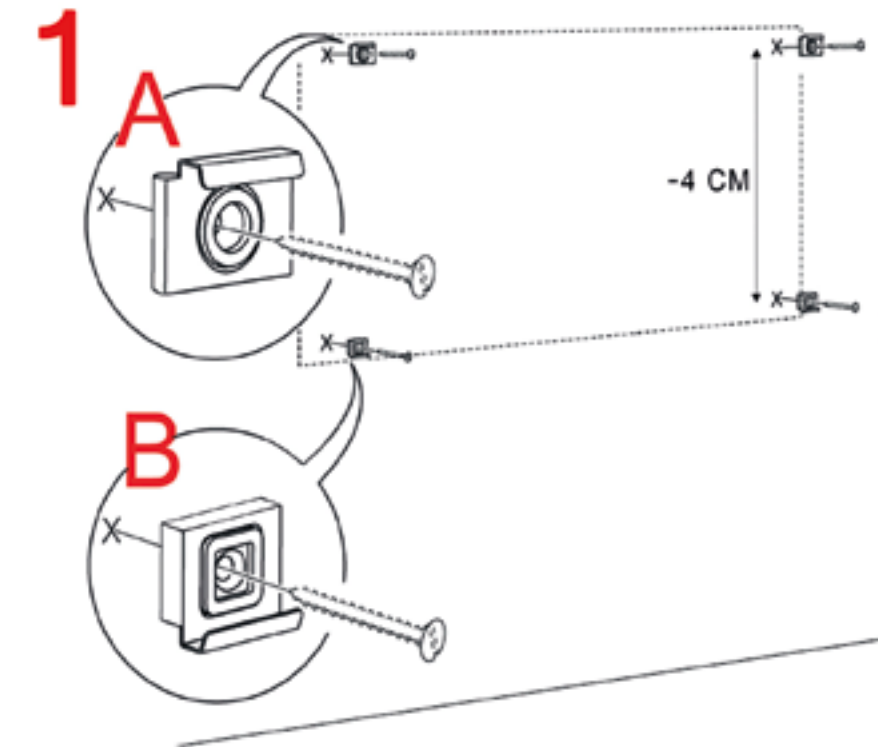

ACCESSORI - SUPPORTS - ACCESSOIRES

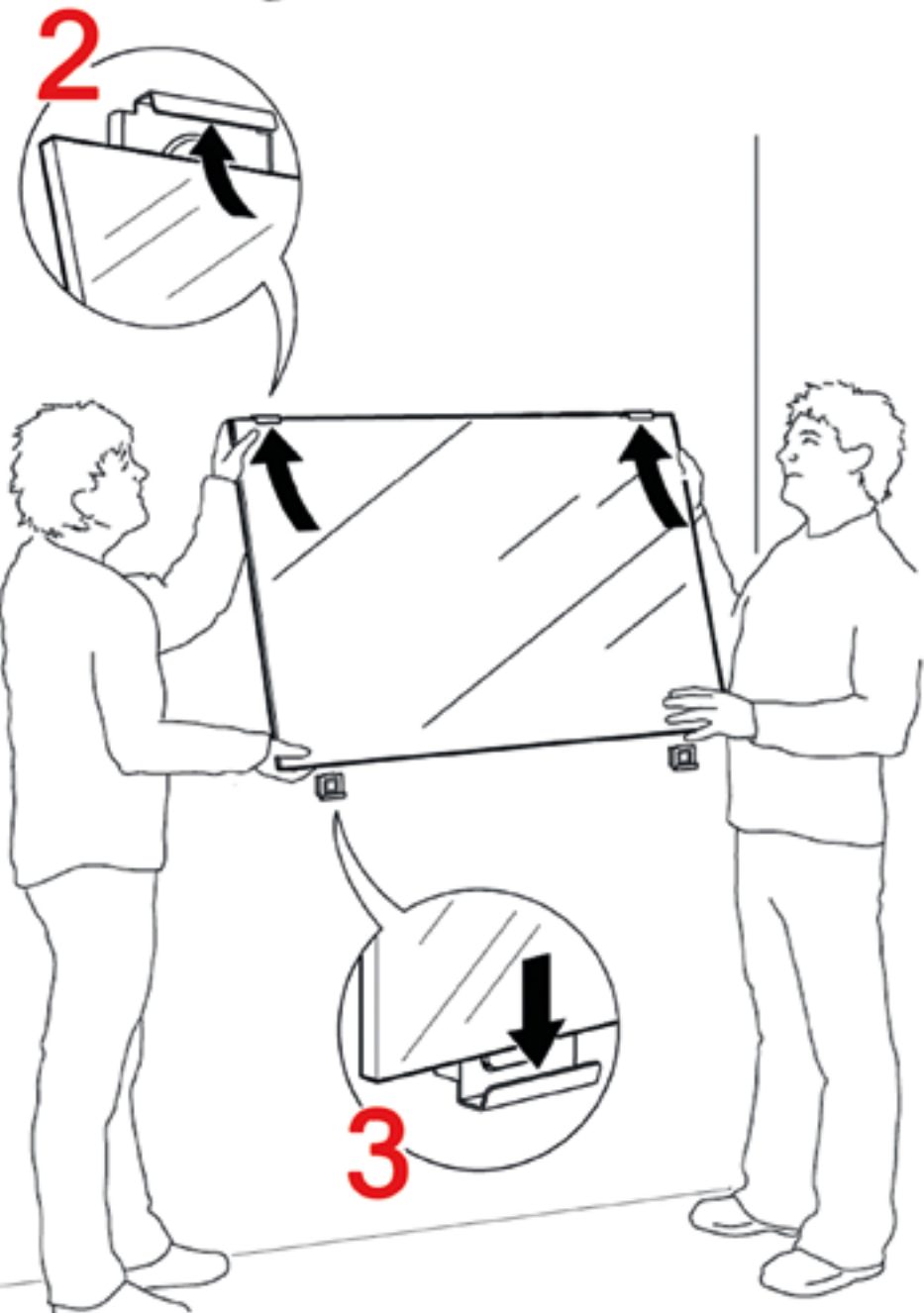
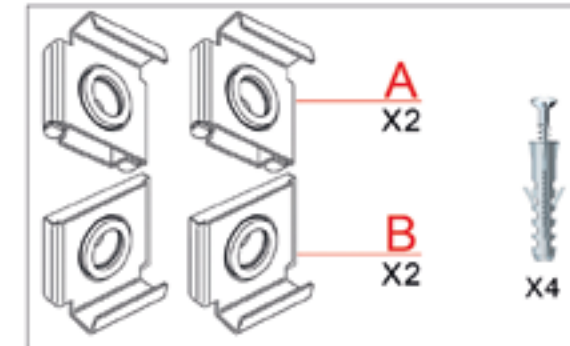

Dopo aver installato i supporti per il montaggio alla parete, inserire il Glass Panel spingendolo verso l'alto sul gancio a molla, poi accostare alla parete e rilasciare verso il basso.

After installing the clips mounting brackets to the wall, insert the Glass Panel by pushing it upwards on their spring, then pull it to the wall and release it downwards.

Après avoir installé les accessoires de montage sur le mur, insérez le Glass Panel en le poussant vers le haut sur les crochets à ressort, puis approchez-le du mur jusqu'aux crochets du bas.



CATAS Testing Certification - Accreditazione
 C. CATAS S.p.A.
 via Aniene, 28/3
 00191 San Giovanni al Palatino (FR)
 tel. +39 0423 747211 - info@catas.com
 www.catas.com

Laboratorio di prova
 via Aniene, 28/3
 00191 San Giovanni al Palatino (FR)
 tel. +39 0423 747212
 info@catas.com

ACCREDIA
 UNI EN ISO 17025
 0423/001

RAPPORTO DI PROVA
273992 / 1

Revisione: 0
 Ricevimento campione: 21/06/19
 Esecuzione prova: 02/07/19
 Emissione rapporto: 04/07/19
 Denominazione campione: Wall Panel

ADRA ART S.R.L.
 VIA PIO LA TORRE 4/A
 47843 MISANO ADRATICO (RN)
 ITALIA

Resistenza delle superfici ai liquidi freddi UNI EN 12720:2013

Prodotti	Tempi di contatto					Valutazione dei risultati
	24 ore	10 ore	6 ore	1 ore	10 min	
Acido acetico (soluz. acquosa 10%)	-	5	-	7	-	1
Acetone	-	-	-	-	5	-
Ammoniaca (soluz. acquosa 10%)	-	5	-	7	-	1
Acido citrico (soluz. acquosa 10%)	-	5	-	7	-	1
Soluzione detergente	-	5	7	7	7	1
Caffè	-	5	7	7	7	1
Etenolo (soluz. acquosa 40%)	-	-	3	5	7	-
Clor di paraffina	5	7	7	7	7	-
Acqua distillata	5	7	7	7	7	-
Soluzione basica	-	-	-	5	-	-

Valutazione dei risultati:
 0 = non necessario
 + = non previsto dalla norma CEN/TS 16209
 5 = nessun cambiamento
 4 = lieve cambiamento visibile solo con luce riflessa
 3 = leggero segno visibile da diverse direzioni
 2 = segno marcato
 1 = segno pronunciato e forte degrado superficiale

Classificazione non oggetto di accreditamento: Classe raggiunta secondo CEN/TS 16209: **B**

Note:
 - Non è stata effettuata l'identificazione analitica del materiale sottoposto a prova.
 - Le sostanze ed i tempi di applicazione, sono quelli previsti dalla norma CEN/TS 16209:2011.
 - Periodo di condizionamento: dal 21/06/2019 al 24/06/2019.

Il documento di formato PDF è stato sottoscritto con firma digitale e viene sottoposto nel rispetto del codice dell'accreditazione digitale (D.Lgs. n° 81 e D.Lgs. n° 159) a una certificazione C.A.D. ai sensi del Regolamento (UE) n° 910/2014 e dell'art. 46 del Codice della Privacy.

CATAS Testing Certification - Accreditazione
 C. CATAS S.p.A.
 via Aniene, 28/3
 00191 San Giovanni al Palatino (FR)
 tel. +39 0423 747211 - info@catas.com
 www.catas.com

Laboratorio di prova
 via Aniene, 28/3
 00191 San Giovanni al Palatino (FR)
 tel. +39 0423 747212
 info@catas.com

ACCREDIA
 UNI EN ISO 17025
 0423/001

RAPPORTO DI PROVA
273992 / 2

Revisione: 0
 Ricevimento campione: 21/06/19
 Esecuzione prova: 02/07/19
 Emissione rapporto: 04/07/19
 Denominazione campione: Wall Panel

ADRA ART S.R.L.
 VIA PIO LA TORRE 4/A
 47843 MISANO ADRATICO (RN)
 ITALIA

Resistenza delle superfici al calore secco UNI EN 12722:2013

Risultati della prova:

Temperatura °C	Valutazione	Descrizione dell'indice numerico
55	5	Nessun cambiamento visibile.
70	5	Nessun cambiamento visibile.
100	5	Nessun cambiamento visibile.
140	2	Zona di lieve danneggiamento.
180	2	Zona di lieve danneggiamento.

Classificazione non oggetto di accreditamento: Classe raggiunta secondo CEN/TS 16209: **C**

Note:
 - Non è stata effettuata l'identificazione analitica del materiale sottoposto a prova.
 - Le temperature di prova concordano con quelle descritte nella norma CEN/TS 16209:2011.
 - Periodo di condizionamento: dal 21/06/2019 al 02/07/2019.

Il documento di formato PDF è stato sottoscritto con firma digitale e viene sottoposto nel rispetto del codice dell'accreditazione digitale (D.Lgs. n° 81 e D.Lgs. n° 159) a una certificazione C.A.D. ai sensi del Regolamento (UE) n° 910/2014 e dell'art. 46 del Codice della Privacy.

AVVERTENZE

- I Pintdecor Wall Panel non sono adatti per essere posizionati dietro i piani cottura con bruciatore a tripla corona posteriore.
- Non mettere pentole roventi a contatto diretto con il pannello.
- Nelle cucine dove è presente l'alzatina attaccata al muro, il Wall Panel deve essere montato sopra l'alzatina.

WARNINGS

- Pintdecor Wall Panel are not suitable to be placed behind the cooktops with a rear triple crown burner.
- Do not put red-hot pans in close contact with the panel.
- In kitchens with the splashback is glued to the wall, the Wall Panel should be mounted above the splashback.

AVERTISSEMENTS

- Les Wall Panel Pintdecor ne peuvent pas être placées derrière des plaques gaz avec une triple couronne à l'arrière.
- Ne pas mettre les poêles chaudes en contact direct avec les crédences.
- Prévoir un plan de travail de profondeur 65 cm pour une plaque gaz.
- Dans les cuisines où il y a un dossier fixé au mur, le Wall Panel doit être monté au-dessus du dossier.

CATAS Testing Certification - Accreditazione
 C. CATAS S.p.A.
 via Aniene, 28/3
 00191 San Giovanni al Palatino (FR)
 tel. +39 0423 747211 - info@catas.com
 www.catas.com

Laboratorio di prova
 via Aniene, 28/3
 00191 San Giovanni al Palatino (FR)
 tel. +39 0423 747212
 info@catas.com

ACCREDIA
 UNI EN ISO 17025
 0423/001

RAPPORTO DI PROVA
273992 / 3

Revisione: 0
 Ricevimento campione: 21/06/19
 Esecuzione prova: 02/07/19
 Emissione rapporto: 03/07/19
 Denominazione campione: Wall Panel

ADRA ART S.R.L.
 VIA PIO LA TORRE 4/A
 47843 MISANO ADRATICO (RN)
 ITALIA

Resistenza delle superfici al graffio UNI EN 15186:2012, met. B

Apparecchio utilizzato: Taber mod. 502

Risultati della prova:

Carico N	Classe raggiunta secondo CEN/TS 16209
0,7	D

Note:
 - Non è stata effettuata l'identificazione analitica del materiale sottoposto a prova.
 - Periodo di condizionamento: dal 21/06/2019 al 02/07/2019.

Il documento di formato PDF è stato sottoscritto con firma digitale e viene sottoposto nel rispetto del codice dell'accreditazione digitale (D.Lgs. n° 81 e D.Lgs. n° 159) a una certificazione C.A.D. ai sensi del Regolamento (UE) n° 910/2014 e dell'art. 46 del Codice della Privacy.

CATAS Testing Certification - Accreditazione
 C. CATAS S.p.A.
 via Aniene, 28/3
 00191 San Giovanni al Palatino (FR)
 tel. +39 0423 747211 - info@catas.com
 www.catas.com

Laboratorio di prova
 via Aniene, 28/3
 00191 San Giovanni al Palatino (FR)
 tel. +39 0423 747212
 info@catas.com

ACCREDIA
 UNI EN ISO 17025
 0423/001

RAPPORTO DI PROVA
273992 / 4

Revisione: 0
 Ricevimento campione: 21/06/19
 Esecuzione prova: 02/07/19
 Emissione rapporto: 03/07/19
 Denominazione campione: Wall Panel

ADRA ART S.R.L.
 VIA PIO LA TORRE 4/A
 47843 MISANO ADRATICO (RN)
 ITALIA

Resistenza delle superfici al graffio UNI EN 15186:2012, met. B

Apparecchio utilizzato: Taber mod. 502

Risultati della prova:

Carico N	Classe raggiunta secondo CEN/TS 16209
0,7	D

Note:
 - Non è stata effettuata l'identificazione analitica del materiale sottoposto a prova.
 - Periodo di condizionamento: dal 21/06/2019 al 02/07/2019.

Il documento di formato PDF è stato sottoscritto con firma digitale e viene sottoposto nel rispetto del codice dell'accreditazione digitale (D.Lgs. n° 81 e D.Lgs. n° 159) a una certificazione C.A.D. ai sensi del Regolamento (UE) n° 910/2014 e dell'art. 46 del Codice della Privacy.

code pagina page

code pagina page

code pagina page

code pagina page

code pagina page

code pagina page

WALL PANEL CLASSIC

WP1004	89 e 91
WP1006	93
WP1010	90
WP1014	92
WP1016	39
WP1020	17 e 24
WP1030	35
WP1032	34
WP1036	19 e 38
WP1040	25
WP1044	39
WP1050	39
WP1056	39
WP1062	38
WP1066	21 e 29
WP1072	35
WP1104	106
WP1112	101 e 103
WP1116	42
WP1122	78 e 162
WP1126	104
WP1128	75
WP1132	110
WP1136	109
WP1138	103
WP1140	103
WP1144	106
WP1146	106
WP1148	107
WP1150	103
WP1152	102 e 162
WP1160	103
WP1162	109
WP1164	111
WP1170	112
WP1172	7 e 113
WP1174	81
WP1176	9 e 115
WP1178	114
WP1188	78
WP1190	86
WP1192	83 e 86
WP1200	85 e 86
WP1202	86
WP1204	87
WP1210	62
WP1214	62
WP1222	57
WP1228	57
WP1230	57
WP1234	57
WP1242	64
WP1246	65
WP1248	13 e 65
WP1252	63
WP1256	77 e 78
WP1258	71

WP1270	72 e 161
WP1272	72
WP1278	69
WP1280	69
WP1282	69
WP1284	68
WP1286	67 e 68
WP1288	68
WP1298	78
WP1306	78
WP1308	72
WP1312	73
WP1322	51
WP1324	49 e 50
WP1326	51
WP1328	50
WP1332	48 e 50
WP1338	50
WP1342	51
WP1348	80
WP1350	79
WP1800	29
WP1802	26 e 28
WP1804	31
WP1806	28
WP1808	53 e 55
WP1810	56
WP1812	31
WP1814	31
WP1816	25
WP1820	93
WP1824	106
WP1826	106
WP1828	96 e 163
WP1830	38
WP1832	111
WP1834	108
WP1836	61 e 63
WP1838	63
WP1840	110
WP1842	38
WP1844	69 e 163
WP1846	47
WP1848	107
WP1850	56
WP1852	56
WP1854	56
WP1856	62
WP1858	59 e 62
WP1860	62
WP1862	63
WP1864	64
WP1868	73
WP1870	87
WP1872	73
WP1874	41 e 43
WP1876	38
WP1878	35

WP1880	45
WP1882	46
WP1884	38
WP1886	72
WP1888	68
WP1890	15 e 68
WP1892	68
WP1894	11 e 70
WP1896	72
WP1898	79
WP1900	69
WP1902	72
WP1904	69
WP1906	73
WP1908	74
WP1910	51
WP1912	108
WP1914	111
WP1916	63 e 160
WP1918	31
WP1920	39
WP1922	51
WP1950	23 e 97
WP1952	24
WP1956	35
WP1960	36
WP1966	97
WP1968	102
WP1970	107
WP1972	39
WP1974	73
WP1976	101
WP1978	110
WP1980	31
WP1982	95
WP1984	94
WP1986	107
WP1988	107
WP1998	33 e 35
WP2000	78
WP2002	99 e 102
WP2004	73
WP2006	37
WP2010	44
WP2012	45
WP2014	44
WP2016	96
WP2018	57
WP2020	57
WP2024	102
WP2026	92
WP2028	54
WP2030	56
WP2032	56
WP2036	50
WP2096	102
WP2098	103

WALL PANEL 3D

WP3D1924	129 e 132
WP3D1928	131 e 133
WP3D1930	137
WP3D1932	143
WP3D1934	133
WP3D1936	138 e 140
WP3D1938	142
WP3D1940	141
WP3D1942	143
WP3D1944	127 e 132
WP3D1946	136
WP3D2008	140
WP3D2050	135
WP3D2052	141

WALL PANEL SPECIAL

WPAS	146
WPSILVER	146
WPRS	146
WPNN	147
WPSP	147

WALL PANEL ARTISTIC

WPA2070	157
WPA2072	157
WPA2074	156
WPA2076	156
WPA2078	153
WPA2080	152
WPA2082	153
WPA2084	155
WPA2086	154
WPA2088	155
WPA2090	151
WPA2092	150
WPA2094	151

WALL PANEL BASIC

WPB2038	159
WPB2040	159
WPB2042	159
WPB2044	159
WPB2046	159
WPB2048	159

ACCESSORI MAGNETIC

WPBARAPPBI	122
WPBARAPPGR	122
WPBARAPPNE	122
WPGANCIOBI	122
WPGANCIOGR	122
WPGANCIONE	122
WPMENSOLABI	122
WPMENSOLAGR	122
WPMENSOLANE	122
WPPORBICBI	122
WPPORBICGR	122
WPPORBICNE	122
WPPORTAZBI	123
WPPORTAZGR	123
WPPORTAZNE	123
WPPORROTBI	123
WPPORROTGR	123
WPPORROTNE	123
WPPORSPEBI	123
WPPORSPEGR	123
WPPORSPENE	123

EXTRA

WPCAMP1515	166
WPESOTAV	166
WPCAMP5030	167
WPPROF	167

GLASS PANEL

GP1414	172
GP1416	172
GP1434	172
GP1436	172
GP1442	173
GP1444	173
GP1446	173
GP1448	173
GP1486	173
GP1488	173
GP1514	173
GP1516	173
GP1534	176
GP1536	176
GP1542	176
GP1544	176
GP1546	176
GP1548	176
GP1562	171 e 172
GP1564	172
GP1574	168 e 172
GP1576	172
GP1690	175 e 176
GP1692	176
GP1698	177
GP1700	177
GP1714	177
GP1716	177
GP1718	177
GP1720	177
GP1730	174 e 177
GP1732	177
GP1950	178
GP1952	178
GP1954	178
GP1956	178
GP1958	178
GP1960	178
GP1962	179
GP1964	179
GP1966	179
GP1968	179
GP1970	179
GP1972	179
GP1974	179
GP1976	179
GP1978	181
GP1980	181
GP1982	180
GP1984	180
GP1986	181
GP1988	181
GP1990	181
GP1992	181
GP1994	181
GP1996	181
GP1998	178
GP2000	178

Adria art s.r.l.

tiene a precisare che i modelli presenti in foto potrebbero subire, in fase di realizzazione, modifiche a scopo migliorativo.

Alcuni articoli presenti in questo catalogo possono uscire di produzione senza preavviso, secondo le esigenze dell'azienda.

Verificare attentamente la qualità degli articoli ricevuti prima del montaggio. Non si accettano reclami riguardanti i prodotti già installati.

Adria art s.r.l. declina ogni responsabilità per danni causati da un'errata installazione o dall'uso improprio dei propri prodotti.

Adria art s.r.l.

reserves the right, without prior notice, to change specifications on the products showed in this catalogue during the construction phase for improvement purposes, according to the company needs.

Some items in this catalog may be put out of production without notice. Check carefully the received items quality before assembly.

Some complaints regarding products already installed are not accepted.

Adria art s.r.l. declines all responsibility for damage caused by incorrect installation or improper use of its products.

Adria art s.r.l.

se réserve le droit de modifier les spécifications des produits présentés dans ce catalogue afin d'en améliorer la qualité ou pour les besoins de l'entreprise. Certains articles pourront être supprimés sans préavis.

Vérifiez soigneusement la qualité des articles reçus avant la pose.

Les réclamations concernant des produits déjà installés ne seront pas acceptées.

Adria Art s.r.l. décline toute responsabilité pour les dommages causés par une mauvaise installation ou une mauvaise utilisation de ses produits.

IMMAGINE E RICERCA: ADRIA ART SRL

PROGETTO GRAFICO: alkimiacreativa.com

STAMPA: LITOS SRL

PINTDECOR®
WALLPANEL
MADE IN ITALY

www.pintdecorwallpanel.it

Pintdecor è un marchio registrato da
Pintdecor is a registered trademark from - Pintdecor est une marque déposée par
Adria Art srl via Luigi Galvani 7/a - 47832 San Clemente (RN) Italy
Ph: +39 0541 659186 - Fax: +39 0541 658186
ordini@adria-art.com - commitalia@adria-art.com - export@adria-art.com

Scopri chi siamo su
For additional details please visit - Pour plus de détails, veuillez visiter
www.adriart.it